

# 4 CH Vehicle Mobile DVR



2012 APR V1.1

<b>4CH</b>	H.264	120/100fps NTSC/PAL	Audio	ALARM	2.5" HDD
-20~+65°C (inside vehicle)	DC 8V~28V	3D G-Sensor	3G 3G Module	GPS	
			TAYPE B	OPTIONAL	

# Index

---

A.	Features.....	1
B.	Specification .....	2
C.	Product Appearance .....	3
D.	Installation 2.5”HDD.....	4
E.	Record / Stop-Record.....	5
F.	System operating instruction .....	6
	Through IR Remote controller instruction.....	6
	Main menu page switch .....	6
	System Setup instruction .....	7
	LIVE Display .....	11
	Playback mode .....	11
G.	Playback .....	12
	1. Through Carbox Player on PC site.....	12
	2. Playback on DVR site .....	21
H.	HDD Format.....	22
I.	Restore Storage Device.....	25
J.	3G-SIM Card Setting (with 3G Module).....	27
K.	Capacity Evaluation of Continuous Recording Storage Device .....	28

## **A. Features**

1. Provide Video output for playing-back mode in mainframe.
2. Recording format: D1 and CIF
3. Support 1CH Audio Input.
4. User friendly player software, easy to operation.
5. Overall quick search event log.
6. The full recording time and date can be showing in the monitor directly.
7. Wide range voltage design.
8. Auto recording after power supplied.
9. Removable HDD Track compatible with 2.5" HDD or SSD.
10. Provide 4 sets of alarm input ports, built-in buzzer.
11. Firmware can be upgraded via USB port.
12. Support recording audio, video, G-sensor and GPS data at the same time.
13. Optional 3G module, for real time monitoring the driving statue, or talk to driver

## B. Specification

Item		Description	
Video Format		NTSC	PAL
Video Input		4CH Input / BNC	
Audio Input		1CH Input / Harness Connector	
Video Output		1CH Output /BNC	
Audio Output		1CH Output /RCA	
Alarm Input		4 Alarm Input	
Alarm Output		Buzzer	
Display Mode		Full Screen, 4 Split, Auto-Switch	
Display Resolution		720 x 480	720 x 576
Recording Resolution	D1	720 x 480	720 x 576
	CIF	360 x 240	360 x 288
Recording Frame		Max. 120 FPS	Max. 100 FPS
Compression Format		H.264 Technology	
Operation System		Embedded Linux Kernel	
Simplex		Record / Playback	
Recording Mode		Real Time Recording	
Delaying-record function after power off		15/30/60/120 Minutes	
LED Indicator		Power, HDD	
Event Mode		Alarm Trigger / Video Loss	
Playback Mode		Normal Speed x1	
		Search Function: Time / Event	
Network		3G module (TYPE B)	
GPS		GPS(optional)	
Storage Type		2.5" HDD	
Firmware Update		USB	
Multi-Language		English / Traditional Chinese / Others (Customizable)	
G Sensor		G Sensor	
Operation		IR Remote Controller	
Power Supply		DC 8V~ 28V	
Dimension		180mm x 210mm x 58mm (W x D x H)	
Weight		3Kg (with bracket without HDD)	
Operation Temperature		-20°C~+65°C ( Inside Vehicle)	
Accessories	Standard	Main Machine, Remote Control, 3 Pin Power Cable, Harness Plug for Video Input , Alarm Cable, Driver CD, Quick Guide	
	Optional	3G Module, G-Mouse	

## C. Product Appearance

### FRONT PANEL

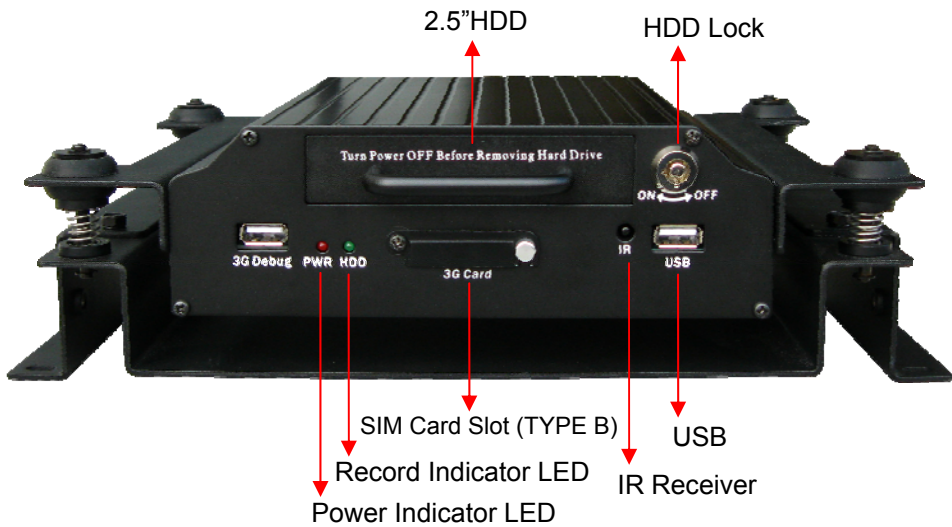

### REAR PANEL

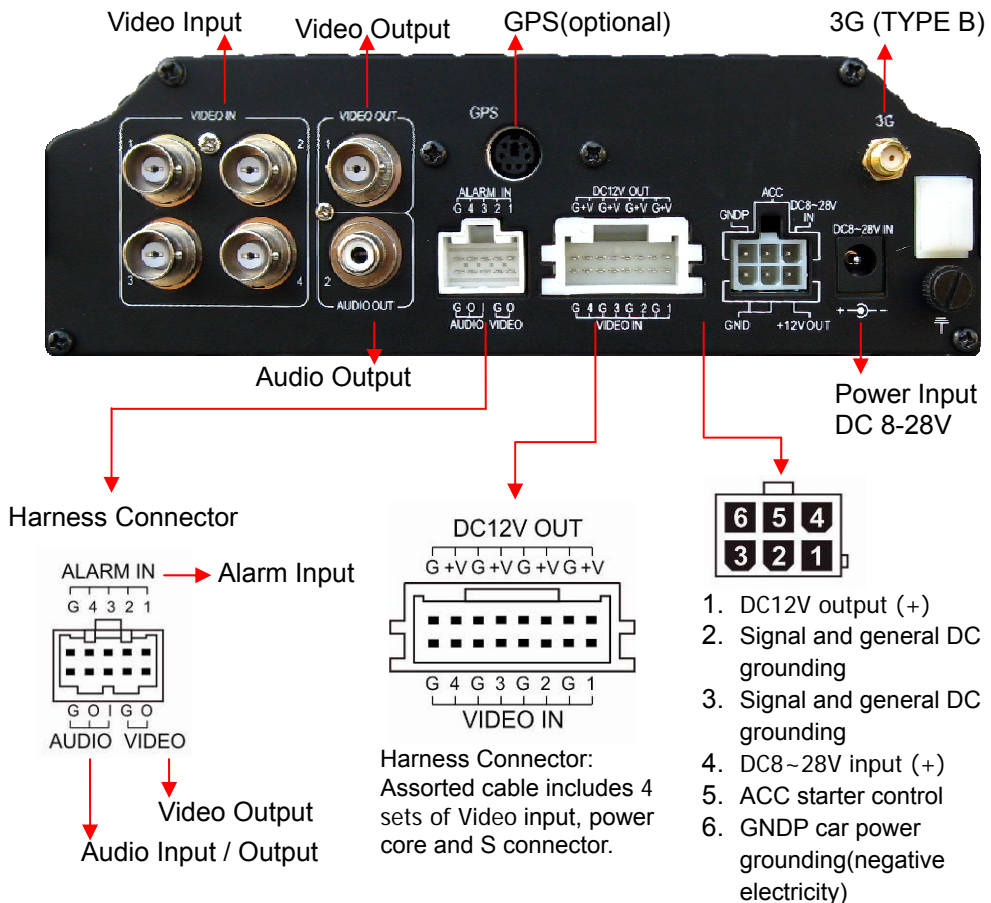

## D. Installation 2.5”HDD



Mobile DVR Hard Disk Drive , screws x4, 2.5” Hard Disk(Optional)



1. Take off the side screws of Hard Disk Drive.



2. Push the hard disk drive connects port out in parallel.



3. Connect the HD flat cable with 2.5”HD, make the alignment between HD & Shockproof plate and put the HD in.



4. Lock four screws to fix the hard disk & Hard Drive Enclosure.



5. Push the cover of hard drive enclosure flatly to connect port.



6. Lock two screws into both sides of hard drive enclosure.



7. Install the hard drive enclosure into mobile DVR and make the lock of hard disk is on “ON” status.

## E. Record / Stop-Record



### 1. Power on / Record

Turn on the power, and it will take approximately 40 seconds to boot up. During the recorder booting up, the HDD indicator LED will start flashing as the recording is in progress.

#### Light indicator:

- Red light: light on, means power on; light off, means no power/power off.
- Green light: light flashing, means HDD take recording; light off means non-recording.

**★Remark: While using playback function in DVR, it cannot take live recording at that time.**

### 2. Power off/Stop recording:

Power off also stop recording, at then you can take out HDD to read the recorded files.

## F. System operating instruction

Vehicle DVR can be operated through two methods: IR remote controller and PC software application.

### ■ Through IR Remote controller instruction

1. As following is the key mapping table for IR Remote controller :



2. DVR OSD menu operation and IR Remote controller key mapping chart

### ■ Main menu page switch

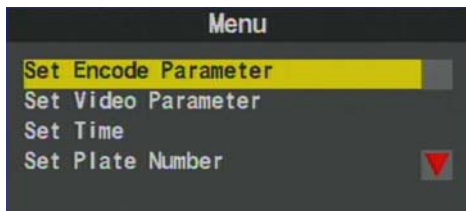

page1/3 setting

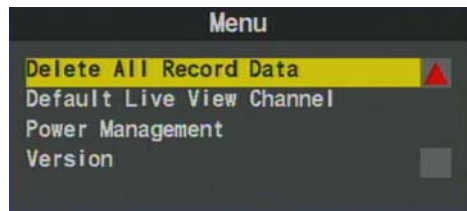

page 2/3 setting

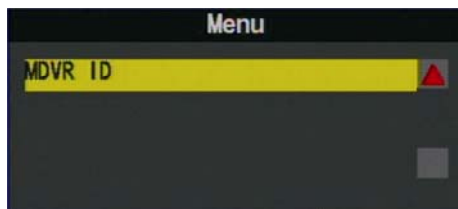

page3/3 (with 3G module)



◆ IR Remote controller Instruction

- (1) Select Item: [up/down/left/right]
- (2) Change setting for selected item: [up/down/left/right]
- (3) Change setting for Bar item : [Enter]
- (4) Full Screen display for each CH: [CH1~CH4]
- (5) Open OSD menu, back to previous page : [menu]
- (6) Quad display : [Quad]
- (7) Enter playback mode : [play]
- (8) Stop Play/exit playback mode : [Stop]
- (9) Suspend recording:[Pause]

■ System Setup instruction

(1) Set Encode Parameter

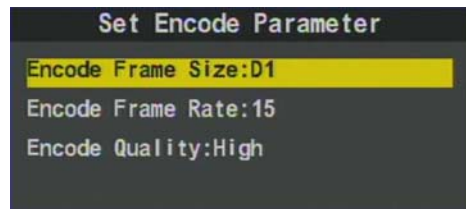
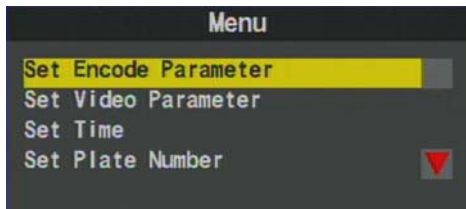

◆ IR Remote controller operating instruction

- (1) Can be selected Resolution/Record frame rate /Recording quality from up/down key on remote controller.
- (2) Left key→ Change parameter.
- (3) Right key→ Back to pervious parameter.

◆ Items Setting

- (1) Encode Frame Size (Res.): D1 / CIF
- (2) Encode Frame Rate: 5/15/20/25/30  
(D1 max. 15 / CIF max. 30)
- (3) Encode Quality: Low/Normal/High

## 2. Set Video Parameter

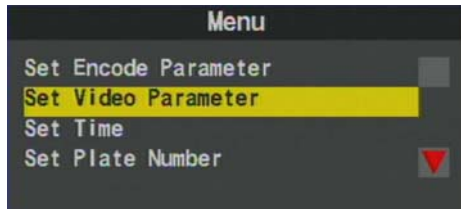

- ◆ IR remote controller operating instruction
  - (1) Up/Down key→ Select current channel for setup
  - (2) Left/Right key→ Set brightness/contrast/hue for current channel (Left key→ To reduce)/ (Right key→ To increase)
- ◆ Item Setting
  - (1) Brightness: (Left key→ to reduce)/ (Right key→ to increase)
  - (2) Contrast: (Left key→ to reduce)/ (Right key→ to increase)
  - (3) Hue: (Left key→ to reduce Hue)/ (Right key→ to increase Hue)

## 3. Set Time

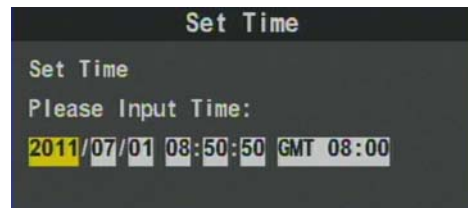
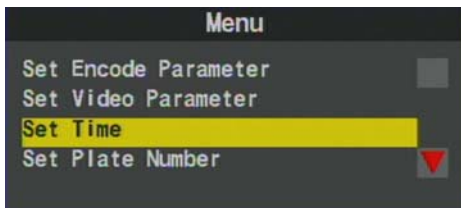

- ◆ IR Remote controller operating instruction
  - (1) Up key→ Plus one, Down key→ Reduce one.
  - (2) Left key→ Left one space, Right key→ Right one space.

## 4. Set Plate Number

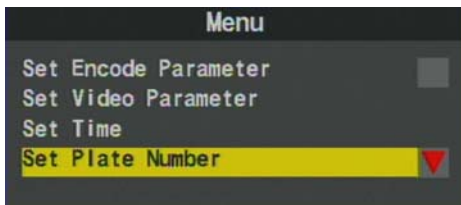

- ◆ IR Remote controller operating instruction
  - (1) Up key→ Numbers plus one or alphabetical order to increase.
  - (2) Down key→ Number reduce one or alphabetical order to reduce
  - (3) Left key→ Left one space.
  - (4) Right key→ Right one space.

### 5. Delete All Record Data (Format Disk)

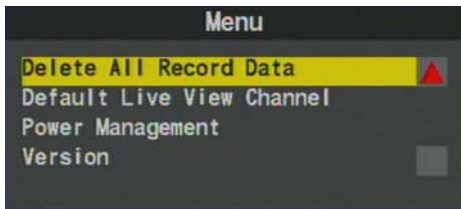

- (1) Delete All Record Data  
Use right key or left key to select the selection then click “enter” to confirm.  
**★Caution! All data will be deleted when you click “Yes”.**

### 6. Default Live View Channel Display

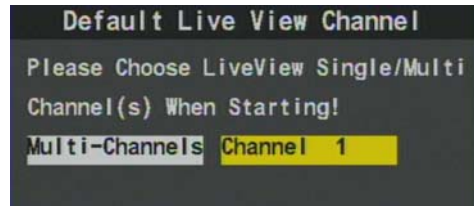

- (1) Select the default live view CH after startup: Item selected will be default live view display mode after DVR booting completed.
- (2) On this page, Use left key or right key to select Quad display (Multi-CH) or CH 1 Display, then press “enter” to confirm.

## 7. Power Management

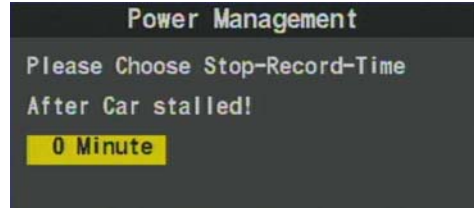
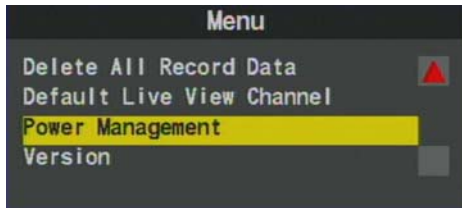

- (1) Power Management: Setup Extended Record period after Engine shutdown.
- (2) Use IR Remote controller for setting, Click Left key to move one space for selecting time for delay-recording, then press enter key to confirm.(The delay-recording period can be 0,5,10,15,20 minutes)

## 8. Check Firmware Version

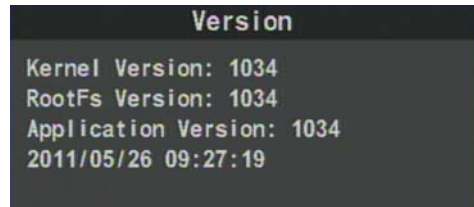
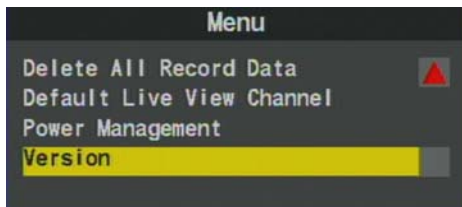

- (1) To check current firmware version, please select version and press enter key.  
★Check the current firmware version first before firmware upgraded.

## 9. Check MDVR ID Information (Only available when DVR with specific 3G module)

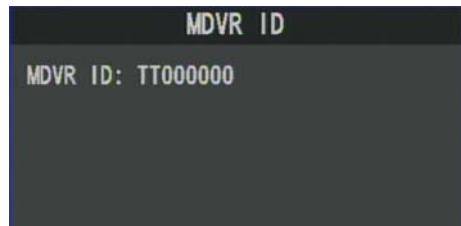
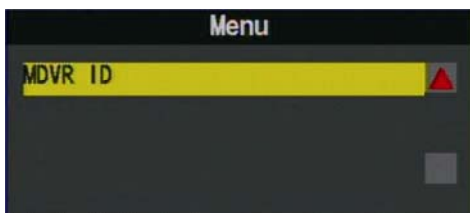

- (1) If you need to check current MDVR ID information, please click MDVR ID and press enter key on remote controller.

★Check the current MDVR ID version is the newest version first before start 3G information setup.

## ■ LIVE Display



- (1) Select CH1~CH4 to full display mode; If you want to return to quad display, please press quad key.
- (2) On Live view mode, click “menu” to enter OSD menu or click “Play” to enter playback mode.

★If it shows the “G” mark on Upper right screen, it means GPS positioning successes.

## ■ Playback mode





Select Decode Items	
Start Record Time	End Record Time
2011/06/30 16:00:46	2011/06/30 17:05:13
2011/06/30 17:05:13	2011/06/30 18:09:41
2011/06/30 18:09:42	2011/06/30 19:14:05
2011/06/30 19:14:06	2011/06/30 20:18:30
2011/06/30 20:18:30	2011/06/30 21:22:53
2011/06/30 21:22:54	2011/06/30 22:27:14
Page 00001	Total Pages 00003

- (1) Select CH1~CH4 as full display for each CH; If you want to return to quad display, please press quad key.
- (2) On Playback mode, please click “stop” to exit the playback mode.
- (3) Press pause key to pause video stream.
- (4) On Pause mode, Press the play key to continue play recording file.

## G. Playback

### 1. Through Carbox Player on PC site

#### (1) Use HDD to playback directly

Execute the CarBox2.exe  from CD-ROM , the display as showing below. Click  Play button to select HDD; or click open file  to choose the files from hard disk, and then double-click the file you want to play. Under playing mode the  play key will switch to  pause key.

★Caution: It needs to install DirectX 9.0 or above before running CarBox2 software.

#### Operating instruction















##### ■ Viewer interface schematic





★GPS Coordinate, Speed and Google Map (select models with 3G modules)

#### a. Control interface description



1		Previous File
2		Previous Frame
3		Backward Play
4		Pause
5		Stop
6		Play
7		Next Frame
8		Next file
9		Open folder, select file.
10		Disk backup. Select the backup path for file storage.
11		Google Map
12		Configuration
13		Snapshot
14		Tool, HDD format, language setting.

- Hard Disk backup 

Review footage on the HDD through PC, Click” ”, then it will pop-up as following backup dialogue windows.

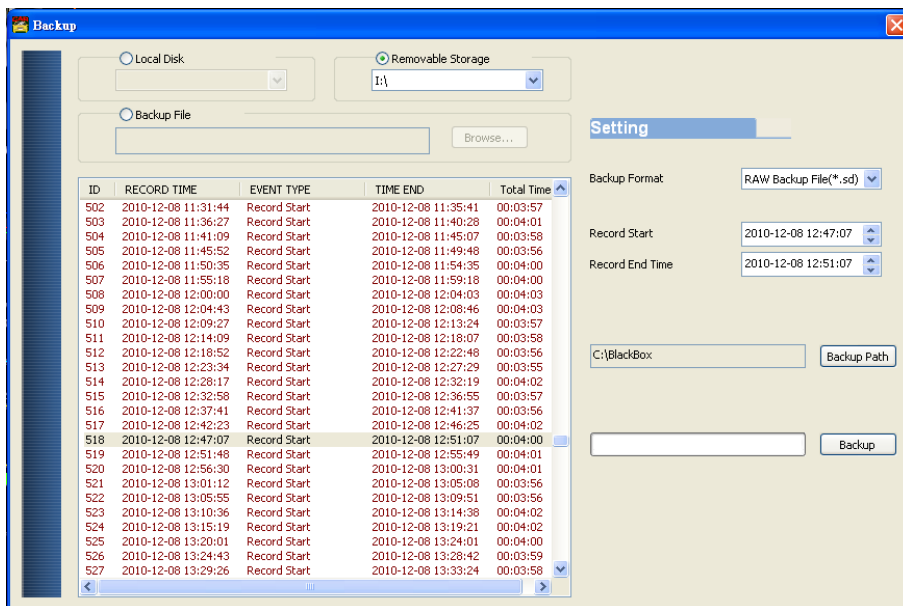

Step 1. Select the HDD drive no.

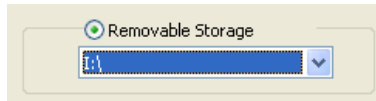

Step 2. Select the recorded file which you want to backup

ID	RECORD TIME	EVENT TYPE	TIME END	Total Time
1	2010-11-13 06:23:32	Record Start	2010-12-07 00:54:20	570:30:48
2	2010-12-07 00:55:04	Record Start	2010-12-07 00:57:54	00:02:50
3	2010-12-07 00:58:38	Record Start	2010-12-07 01:01:29	00:02:51
4	2010-12-07 01:02:14	Record Start	2010-12-07 01:05:05	00:02:51
5	2010-12-07 01:05:49	Record Start	2010-12-07 01:08:40	00:02:51
6	2010-12-07 01:09:24	Record Start	2010-12-07 01:12:15	00:02:51

Step 3. Select the Backup Format

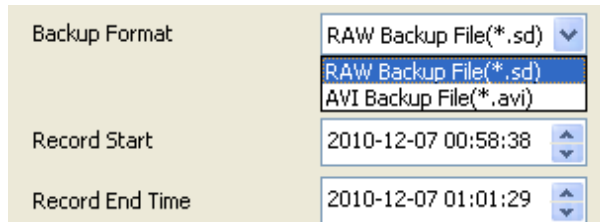

Backup format:

(1) RAW backup file. Specific .sd format

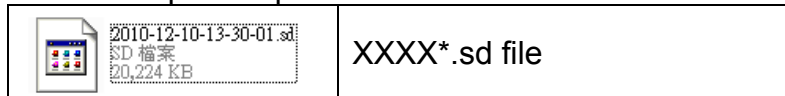

(2) AVI File(\*.avi) backup when take this format as backup

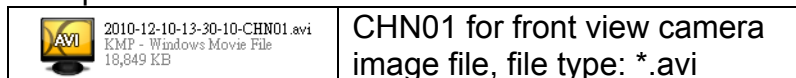

★caution : The difference between .sd format and .avi format is that AVI file contains only video and audio data but lose the GPS coordinates, speed and G-sensor data. so, we would recommend to select .sd format when you back the file.

Step 4. Backup Path: Select your backup destination (e.g.: C:\BlackBox)

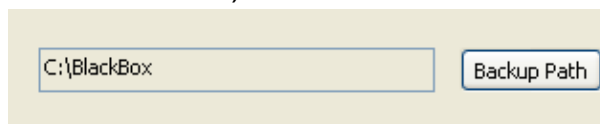



**Step 5. Backup:** Click 'backup' to start saving the file to your specified destination

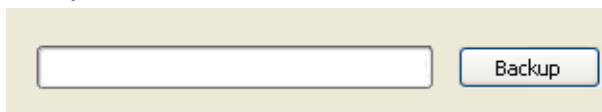

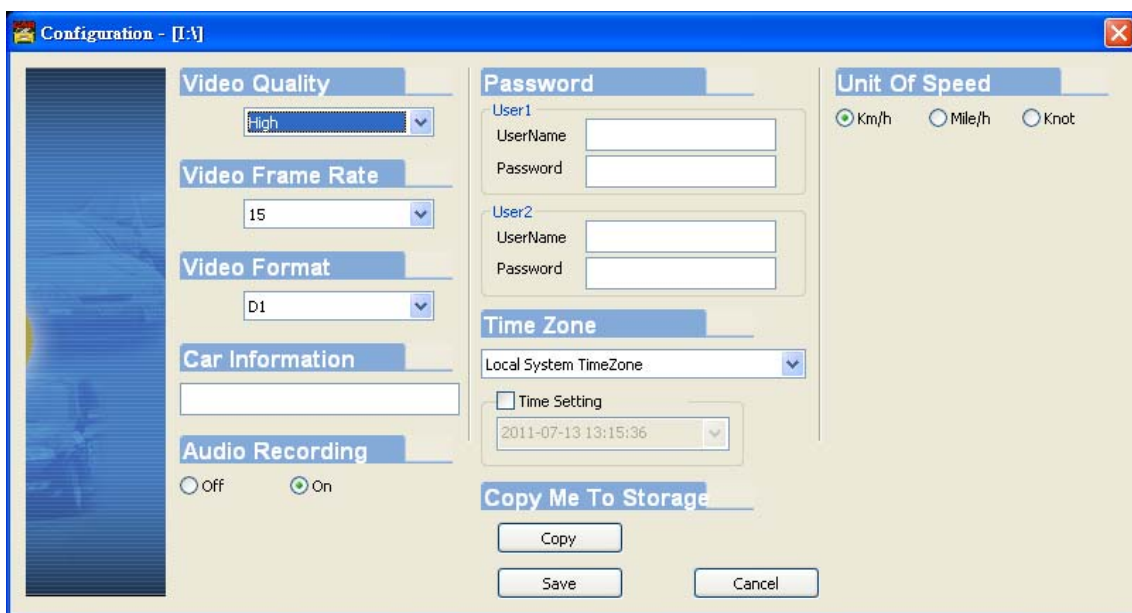

■ Configuration 

Before start recording, please configure the setting well and then plug HDD into the host. The configuration interface of its options detailed instructions, please see the operation manual of CD-ROM.

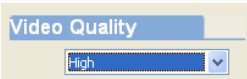
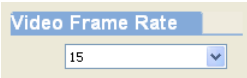

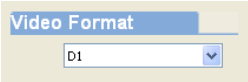
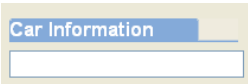
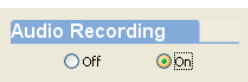
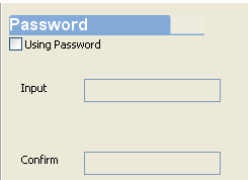
1	Video Quality		Select the video Quality: High/ Normal / Low
2	Video Frame		Set the recording frame rate for the camera (2、4、6、8、10、15、20、25、30)

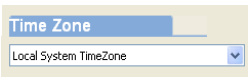
3	Video Format		video signal format D1/CIF
4	Car Information		You can input the driver's name or license number here to identify people's identity. Suitable for company or group using.
5	Audio Recording		Audio recording on or off.
6	password		<p>This function can encrypt the data and prevent others from accessing. Maximum letters:15 letters. Example: 123456789123456</p> <p>After setting the password up, you have to input password every time for playing the files, modify the setting, formatting the HDD etc.</p> <p>★ Note: Please check if you have set capital letters for your password and save your password well in other place to prevent from missing.</p>
7	Speed unit		<p>You can set up the speed unit here.</p> <p>Km/h: kilometer per hour Mile/h: mile per hour Knot: knot per hour</p> <p>★ Note : 1 KM=0.6214 mile, 1 mile=1.6093KM, 1 Knot =1.853KM</p>
8	Time zone		Time Zone: GMT (GPS auto time correction)

■ Snapshot 

While playing the recorded file, you can use this function 

to snapshot the picture and save it into your PC.  
 Default saving path for snapshot picture will be in  
 x:\IBoxPlayer/Snapshot folder. File type: .bmp



b. Latitude & Longitude Coordinates

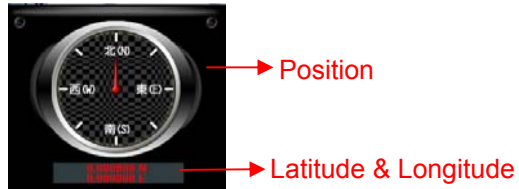

c. G SENSOR

G-sensor: Detect & record G-force data.



- (1) X: The G-force from left & right of the car.
- (2) Y: The G-force from front & back of the car.
- (3) Z: The G-force from upside & downside of the car

d. Speed meter



e. Video Search & Play Speed



- (1) Video Searching : You can use the mouse to drag the bar to search the video quickly.
- (2) Play Speed : Support 2x, 4x fast forwarding and -2x, -4x slow play mode.

f. Volume control





Volume BAR: Click the left button of mouse control to adjust the volume degree.

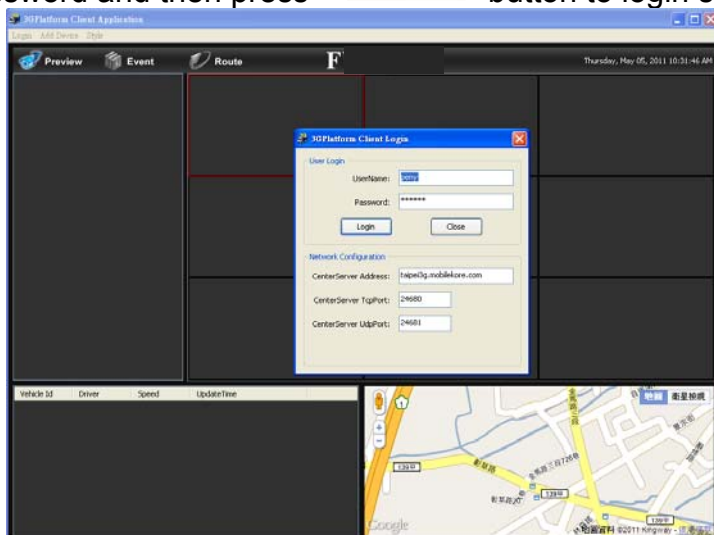

(2) 3G client software for viewing directly(select models with 3G modules)

Executive Playback software “3G ClientApp.exe”, the playback screen shown as below. Enter the username and password and then press “” button to login screen.





★ Note: To perform this software will require DirectX 9.0 or more.

Click  Preview and then select the name of vehicle to view the image(example, the figure of 175) Then click on Channel-01 (or other Channel) and then hold down the left mouse button and drag to the split screen in right side.

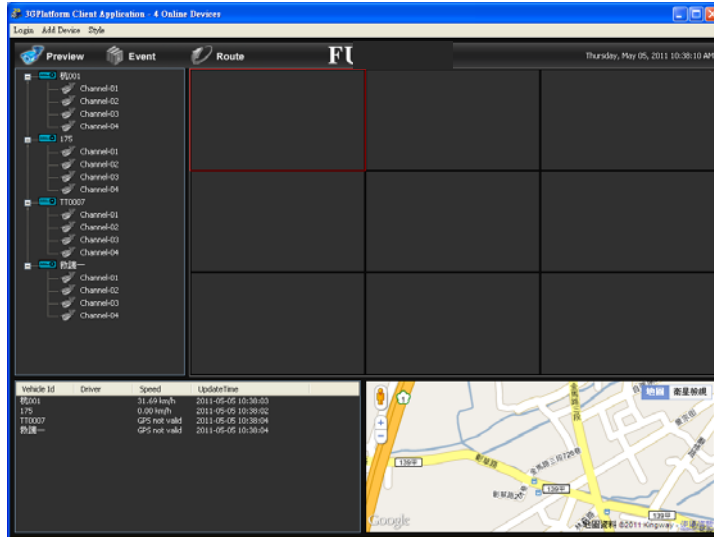
The other method to choose split-screen first and then click on Channel-01 with right key of the mouse, click PLAY function to view real-time image.( When the icon becomes , it means the vehicle that is currently offline. Only the icon return to online status  to see the real-time image.)



★ Note: When play real-time image, Channel icon will become green .

Click  can watch the event log and vehicle driving records...

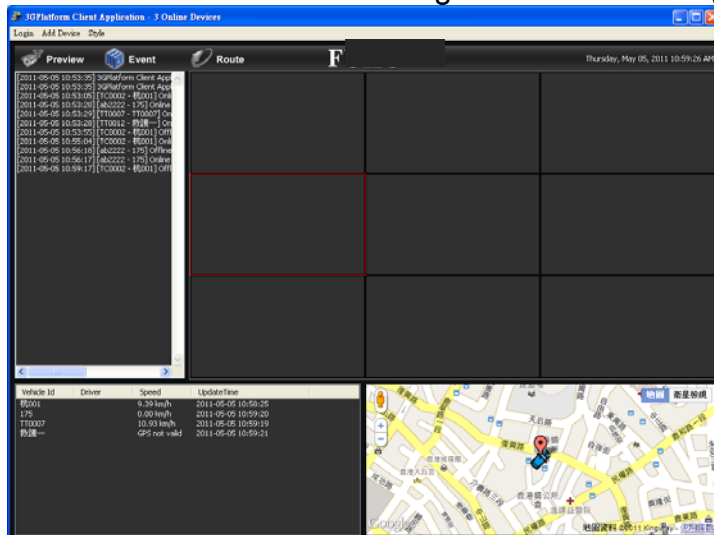

Click  can watch the Google Map and inquiry the date and time record of the vehicle.....

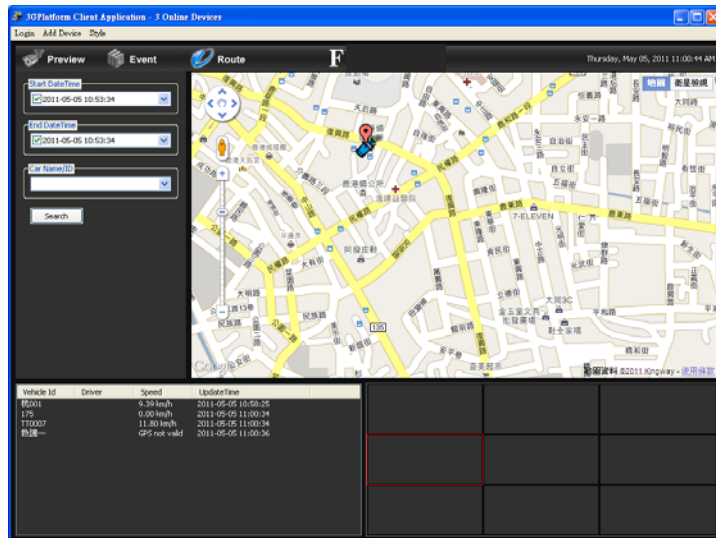

### ■ 3GClientApp page and other relevant settings

Login Add Device Style

1. Login: click Login on the top of the screen to open the login screen information.
2. Add Device: In order to identify each device, add the vehicle information here.
3. Style: watch different split-screen, just click Style option to set values; Total 1 \* 1,2 \* 2,3 \* 3,4 \* 4,4 types of split screen to choose.

## 2. Playback on DVR site

- a. Use remote controller to enter playback menu



- b. Use remote controller to select playback file, and enter playback screen





- c. Press stop key on remote controller to exit playback screen.

## H. HDD Format

When should you format the HDD?

For brand new HDD or an used HDD which is used in other equipment before, it should be formatted before using.

- HDD Format on PC through specific software.
  1. Connect the storage device / hard disk to PC.
  2. Execute CarBox.exe , one click  to act format function.
  3. Select the path of HDD, and click “Format” to start formatting.

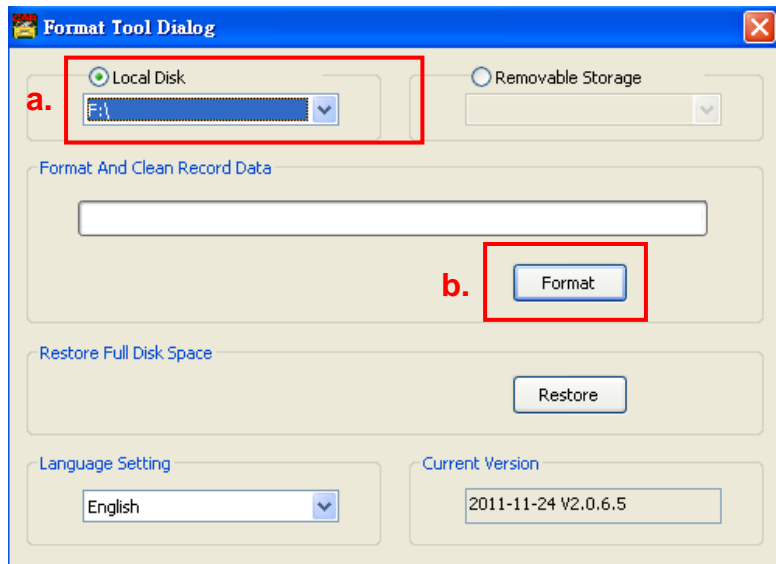



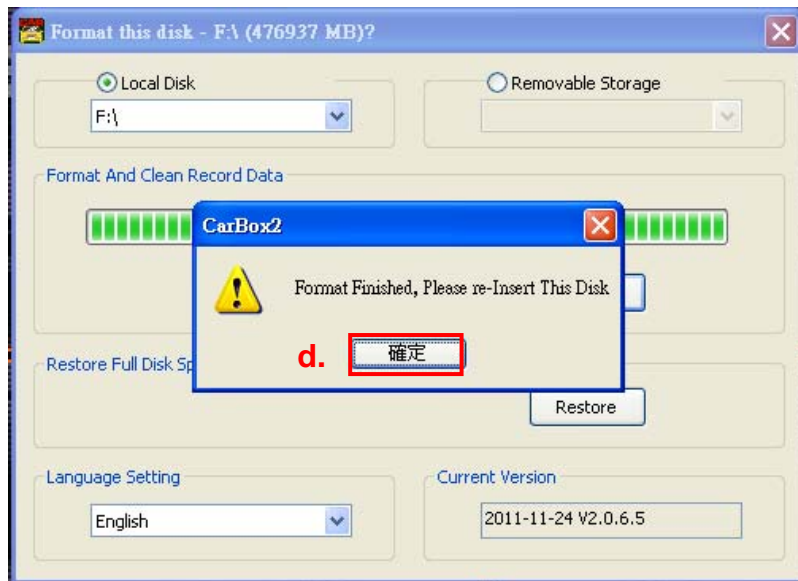
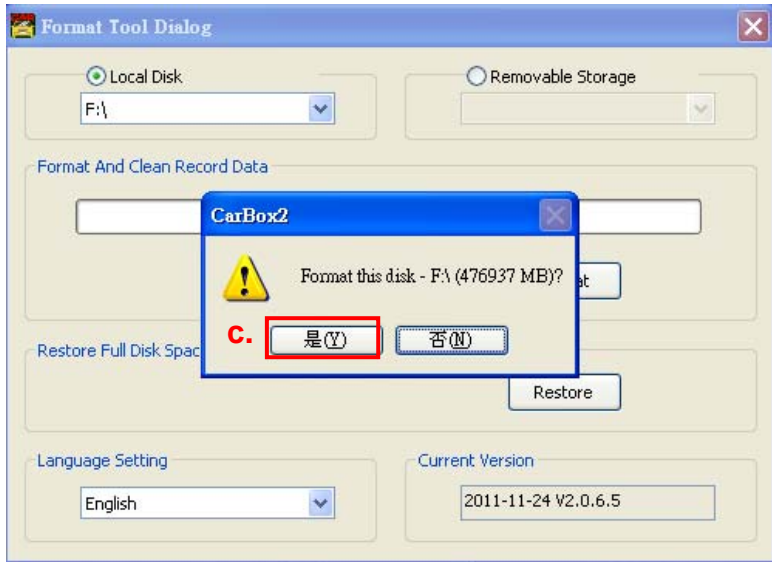

4. After format, re-plug the storage device, then you can set up related parameters and save. After setting, Install the HDD into the DVR and it can start to work.

■ Process to Format the HDD on DVR:

1. Use remote controller to enter DVR menu and choose Delete All the Record Data(format disk).

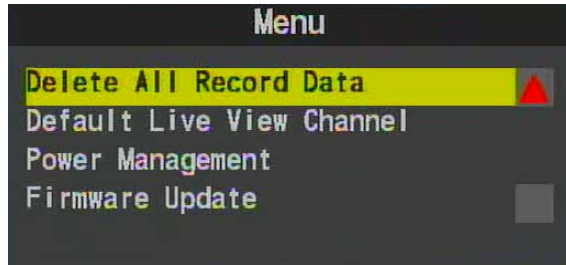

2. Select "Yes" and Click "Enter" to start formatting.





3. When the screen back to LIVE mode ,the formatting is completed.

## I. Restore Storage Device

When the storage device should be restored?

If the storage device(HDD) will be used in other purpose., please back-up record footages to PC firstly and then restore it.

### ■ Restore Storage Device(HDD) on PC

1. Connect the storage device (hard disk) to PC.
2. Execute CarBox.exe , one click  to enter the following page.
3. Select the path of HDD and click “Restore” tab to start restoring.

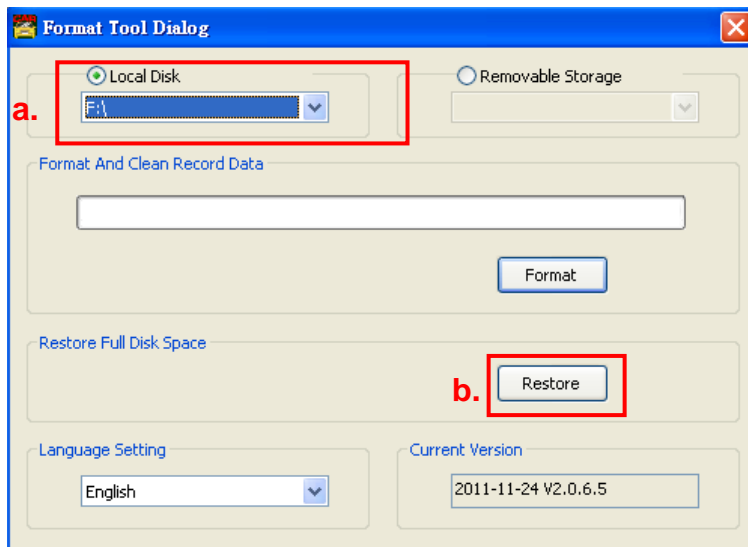

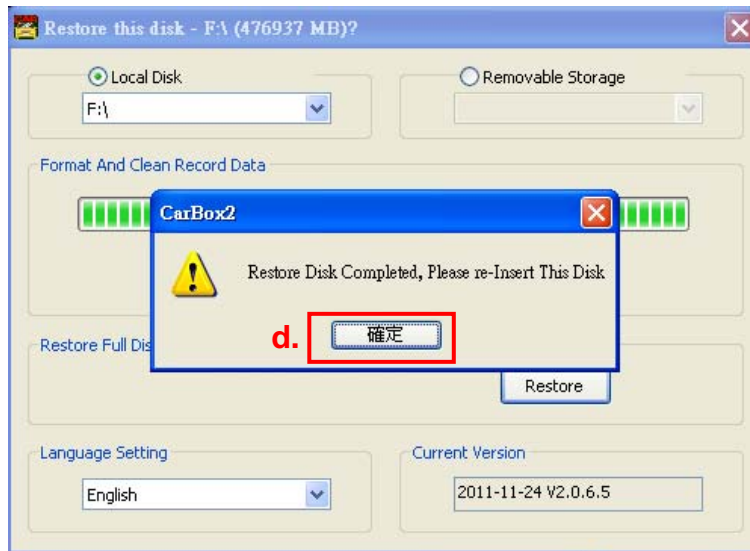
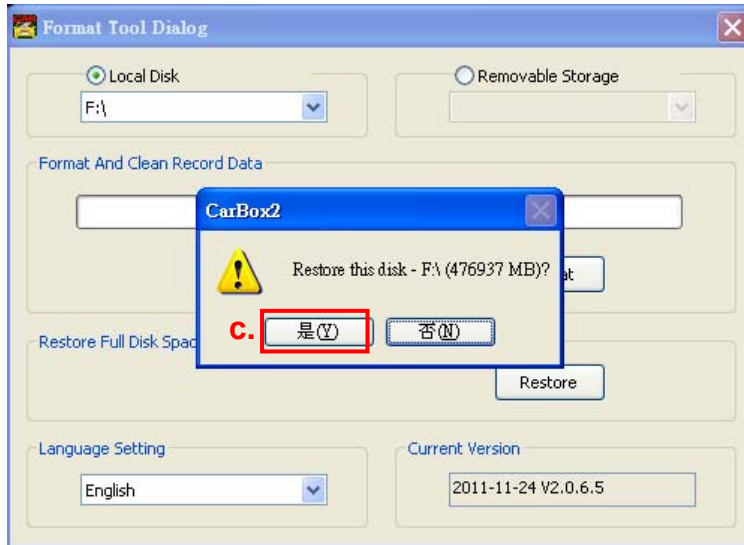

4. The storage device can be used in other device after restore action completed.

## J. 3G-SIM Card Setting (with 3G Module)

When use SIM card in our device, please pay attention to off the PIM code protection feature first.

How to turn off the PIN code protection?

1. Using HUAWEI 3G Module and then plug the SIM card into PCI-E board first. Second, use USB cable to connect PC and PCI-E board and then open the Mobile Partner Program.



2. When open the program, select Tools \ PIN Operations \ Disable PIN Verification ..

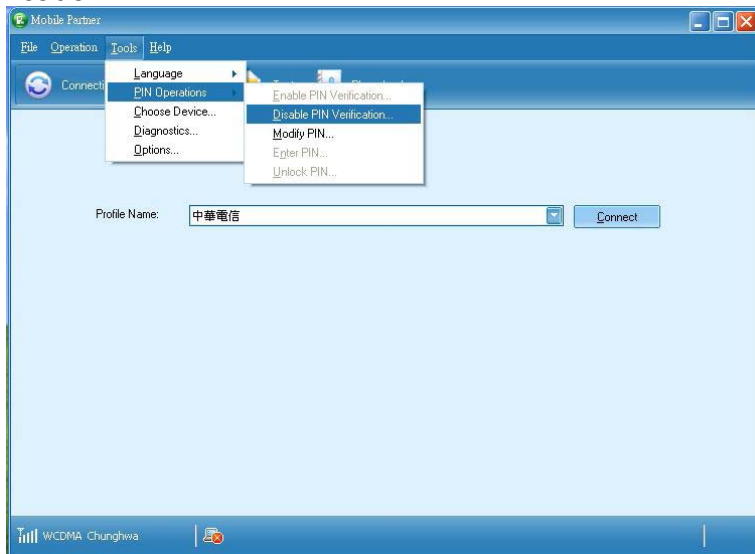

3. Enter correct PIN code (default Chunghwa Telecom: 0000)

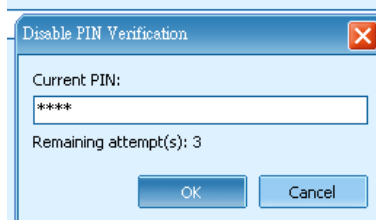

4. Confirm entering correct PIN code and then complete the cancellation PIN code function.



5. After completing above procedure, HUAWEI 3G Module and SIM card on our PCI-E board could connect to 3G system well.

★Unplug the USB cable and replace the original wiring connected to PCI-E board. At this time connect device power and camera well, device will send real-time image to 3G server automatically.

## K. Capacity Evaluation of Continuous Recording Storage Device

Assumption of the minimum record time for Mobile DVR: 2 Channels, Statics Recording and different capacity of Hard Disk.  
The following recording table is evaluated by 1Gb.

Unit: Gb / Min.

Resolution/ fps	D1			CIF					
	5 fps	10 fps	15 fps	5 fps	10 fps	15 fps	20 fps	25 fps	30 fps
High	72 Min	32 Min	23 Min	112 Min	100 Min	64 Min	60 Min	56 Min	52 Min
Normal	90 Min	50 Min	47 Min	135 Min	107 Min	67 Min	62 Min	60 Min	56 Min
Low	126 Min	54 Min	90 Min	150 Min	133 Min	107 Min	84 Min	72 Min	69 Min

★ The length of time recorded can be varied due to different record condition.