

# 360° Vehicle Surveillance System

4 channel VVR / all in one 4 channel vehicle video recorder

---



User Manual

2013 AUG V1.0

---

## Mobile DVR



## Camera



# Safety Precautions

---

Take and review some testing video initially to make sure the images were recorded correctly. Please note that manufacturer, its subsidiaries and affiliates, and its distributors are not liable for consequential damages arising from any malfunction of main device accessory, including memory device that results in the failure of an image to be recorded or to be recorded in a way that is machine readable.

**Before using the product, please ensure that you read the safety precautions described below. Always ensure that the product is used correctly.**

- Please keep device away from children.
- Use only recommended power sources.
- Do not attempt to disassemble, alter or apply heat to the product.
- Avoid dropping or subjecting the product to severe impacts.
- To avoid the risk of injury, do not touch the interior of the product if it has been dropped or otherwise damaged.
- Stop using the product immediately if it emits smoke, a strange smell, or otherwise behaves abnormally.
- Do not use organic solvents such as alcohol, benzene, or thinner to clean the product.
- Do not let the product come into contact with water (e.g. sea water) or other liquids.
- Do not allow liquids or foreign objects to enter the VVR.
- Do not place the VVR near or in direct flame.
- Do not handle the power cord with wet hands.
- Do not use the equipment in a manner that exceeds the rated capacity of the electrical outlet or wiring accessories. Do not use if the power cord or plug are damaged, or not fully plugged into the outlet.
- Do not allow direct or metal objects (such as pins or keys) to contact the terminals or plug.
- Avoid using, placing or storing the product in the humid or dusty areas.

---

## Table of Contents

---

A. Features.....	1
B. Specification.....	2
C. Accessories .....	4
D. Product Dimension.....	5
1. Mobile DVR Dimension .....	5
2. Appearance of Camera .....	7
E. Installation.....	8
1. DVR Wiring Diagram .....	8
2. Camera Installation Diagram.....	10
3. How to install Memory Card.....	11
F. ON/OFF .....	12
G. Remote Controller Introduction.....	14
H. Real Time Monitoring Mode.....	16
I. Playback Instruction .....	17
1. To playback in main engine.....	17
2. To Playback in PC.....	18
J. Menu Operation On The Mobile DVR.....	21
1. Main Menu .....	21
2. Menu OperatiOn And Parameter Setup.....	22
(1). Video recording setting .....	22
(2). Parking setting .....	23
(3). Color adjustment.....	23
(4). Time setting.....	24
(5). Vehicle number setting .....	24
(6). Format the disk .....	25
(7). Live screen mode setting .....	25
(8). Power Management.....	25
(9). Alarm setting.....	26
(10). Password setting.....	26

---

(11).	G-Sensor setting.....	27
(12).	Restore to Factory setting.....	27
(13).	Language setting.....	28
(14).	Firmware upgrade.....	28
(15).	Firmware version .....	29
K.	Player (On the personal computer).....	30
(1).	Capture.....	30
(2).	Configuration .....	31
(3).	Backup.....	34
(4).	Playback.....	37
(5).	Format .....	37
(6).	Footage playback speed .....	38
(7).	MAP .....	38
(8).	G-sensor .....	39
(9).	Footage playback speed .....	39
(10).	Volume.....	40
(11).	Control panel .....	40
(12).	Direction and Latitude.....	41
(13).	Speed .....	41
L.	Format the SD card.....	42
1.	Format on the recorder.....	42
2.	Format in your computer.....	43
M.	Restore the SD card.....	46

## A. Features

- All New Parking Surveillance Mode:
  - Programmable recording time-reduce vehicle battery exhausting.
  - Programmable fps - prolong recording time.
- Mobile DVR with 4CH 360° camera; Leaving no blind spots of your surroundings.
- H.264 Video compression technology with D1& CIF resolution.
- Quick search on event records-Easy and reliable.
- Time & date are included in every footage.
- Auto recording after power on.
- SDHC card storage-free from shock and vibration.
- Firmware updatable via USB.
- Fully recording video, audio, G-sensor, and GPS inputs.

## B. Specification

- Mobile DVR

Item	Description		
Signal type	NTSC/PAL		
OS	Embedded Linux		
Video input	1CH		
Video output	1 CH AV		
Audio input	1CH input		
Audio output	1CH AV		
Alarm-in	1 input		
Interface	Icon 、 Multi-language(English, Traditional Chinese, Simplified Chinese)		
Display FPS	NTSC	120 fps	
	PAL	100 fps	
Recording FPS	NTSC	30fps@D1 (real time recording) per camera	
	PAL	25fps@D1 (real time recording) per camera	
Playback FPS	NTSC	30fps@D1 (real time playback)	
	PAL	25fps@D1 (real time playback)	
Display mode	Spherical 360 degree image		
Multi-function	Recording/Playback		
Resolution	Display	NTSC	720 x 480
		PAL	720 x 576
	Recording	NTSC	360*240@CIF 720*480@D1
		PAL	360*288@CIF 720*576@D1
Compression Quality	H.264	1(poor) ~ 5(excellent)	
Storage	SDHC		
Back up	With CARBOX software		

Playback	Mode	time/date, event
	Full screen	Yes
LED indicator	3 LED (REC、GPS、POWER)	
Brightness	Yes	
Contrast	Yes	
Signal off Detection	Yes	
Buzzer	Yes	
GPS	G-MOUSE (Optional) with Google Map display	
G-SENSOR	Yes	
IR	Yes	
Extending IR	Yes	
Monitoring Mode	Auto recording after power on	
Power input	(1) DC 8V~32V (2)ACC Auto Power-off Programmable	
Dimension	115X90X30(mm)	

- Camera

Signal type	NTSC	PAL
Sensor	1/4 inch CMOS *4PCS	
Video processor	Digital	
Pixel	640 (H)×480 (V)	640 (H)×576 (V)
Total pixel	300K	370K
Resolution	420 lines	
Input voltage	DC 12 ± 1V	
Current	200mA (IR OFF)	
Sync . system	Internal Synchronization	
Scan system	2:1 crossover	
Sensitivity	10 V /(Lux-sec) / 0Lux(IR ON)	
Signal to Noise Ratio	Max. 45 dB	

Auto-zenith control	Open automatically
Dynamic range	65 dB
Auto-balance	Automatic
Shutter status	Automatic
Viewing angle	H : 360° V : 70°
Signal output	1 Vp-p standard video output,75 Ω
IR LED	4PCS
IR range	1m
Operation Temperature	- 10° C ~ +60°C

- Notes:
1. Storage devices purchase separately.
  2. No further notification on product specification changes.

## C. Accessories

### 1. In the box :

- (1) Device
- (2) Camera
- (3) Power cord (black/blue/red)
- (4) Alarm cable (black/yellow)
- (5) IR extension cord
- (6) Remote controller
- (7) Microphone
- (8) Velcro strap
- (9) Sticker
- (10) Bracket mount
- (11) CD
- (12) Quick start guide

### 2. Option :

- (1) G-Mouse
- (2) SD card



## D. Product Dimension

### 1. Mobile DVR Dimension

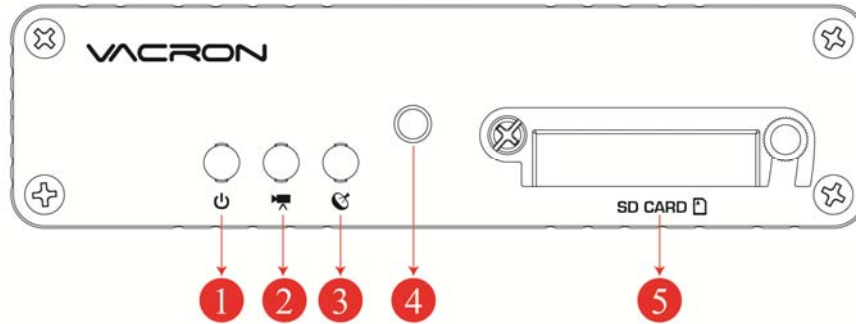

- (1). Power Light
- (2). Recording Light
- (3). GPS Light
- (4).IR receiver
- (5).SDcard Slot

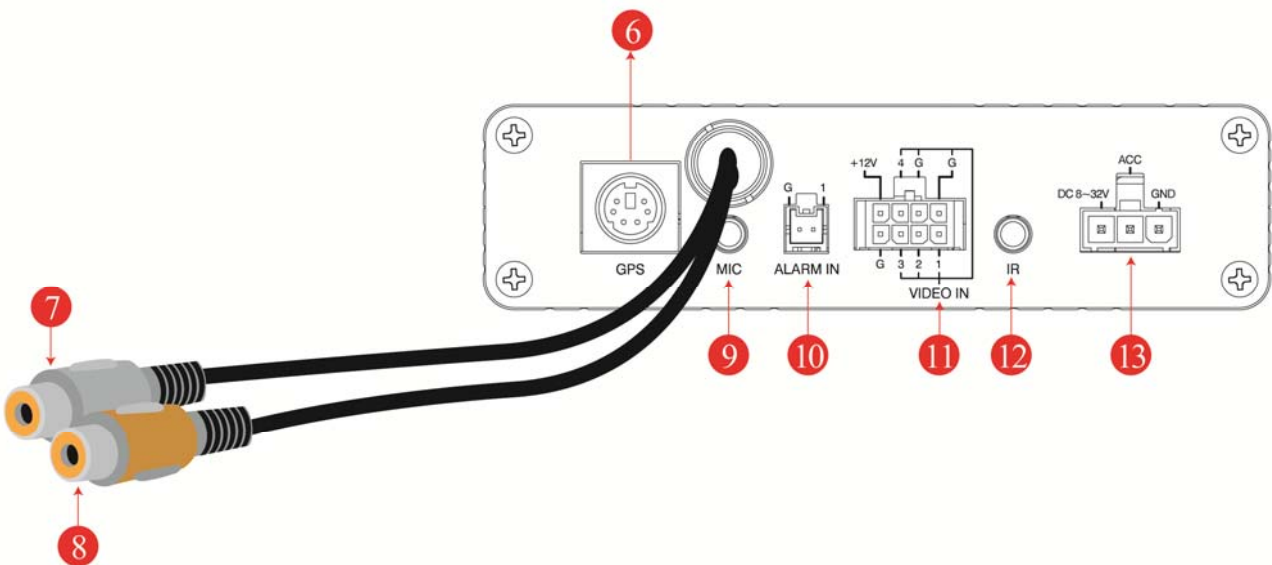

- (6). GPS Connector : To connect with G-Mouse (GPS sensor) to start GPS function. It can record vehicle location, speed, longitude and latitude.
- (7). Audio output: "A" means "audio output" .
- (8). Video output: "V" means "video output"
- (9). Micphone hole : To connect with microphone to

recording audio.

- (10). Alarm Input: Alarm input connector.
- (11). Camera connector: In pair with AVM-360PV, it can support 360 degree recording.
- (12). IR extension cable connector: Once upon connecting with the extension cable, the IR receiver will be adjusted to the end of cable.
- (13). PowerConnector: To cooperate with power management function (in OSD), it can provide 「Delay Shutdown」 function.

Dimension (Unit: mm)

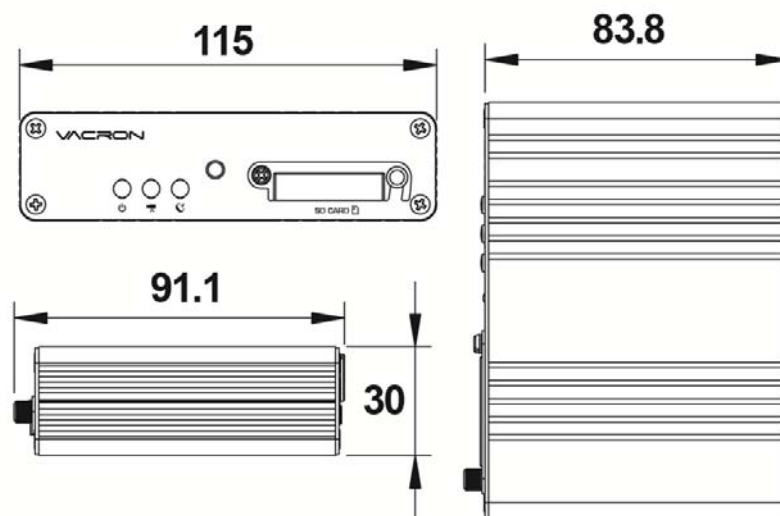

## 2. Appearance of Camera

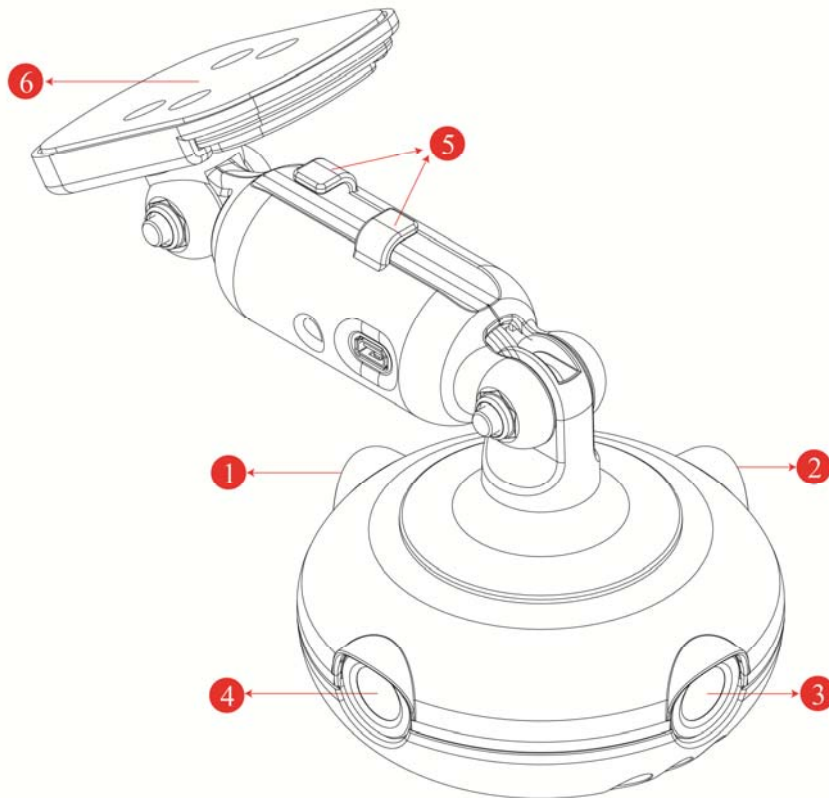

- 1. Lens 1 (Front)
- 2. Lens 2 (Right)
- 3. Lens 3 (Inner)

- 4. Lens 4 (Left)
- 5. Cable collect slot
- 6. 3M tape

### Dimension (Unit: mm)

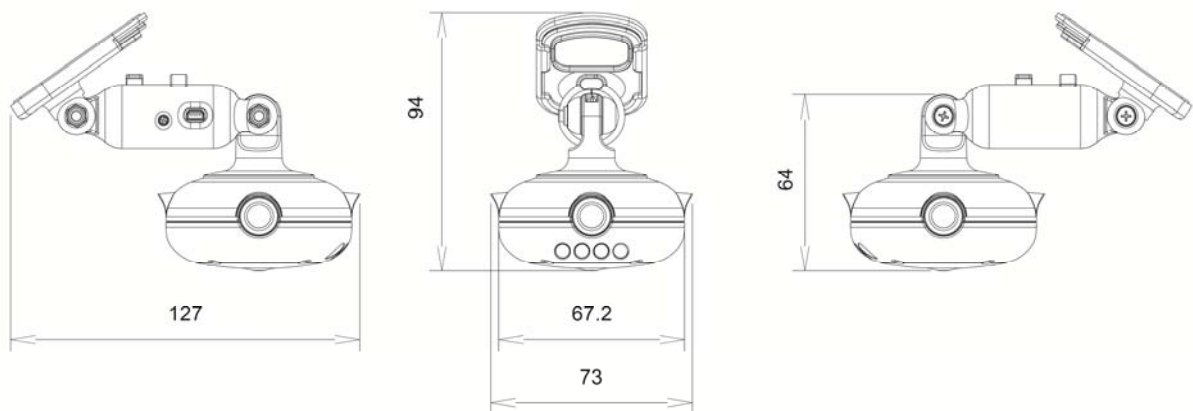

## E. Installation

### 1. DVR Wiring Diagram

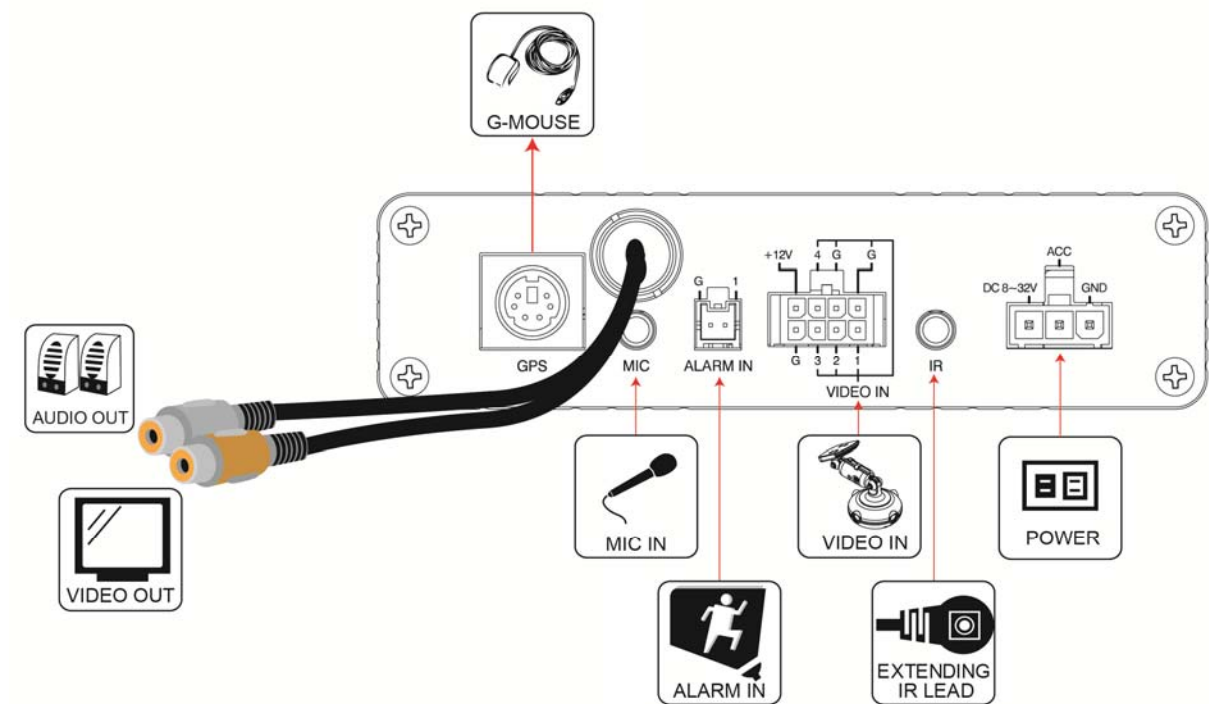

- Power Cable (Black/Blue/Red)

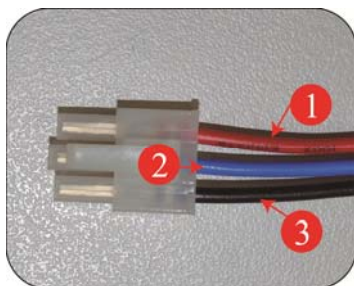

1. RED : Positive Port (DC8~32 input)
2. Blue : ACC control
3. Black: GND

- Alarm Cable

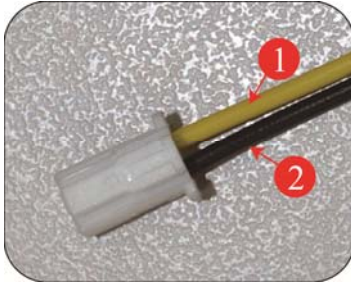



1. Yellow : Positive Alarm Input (12V)
2. Black : GND



### Notice

- (1). To protect your vehicle, please have professional technician to install this mobile DVR.
- (2). Please keep all the connectors clean from dust with temporary tape during installation. If not, dust gets into connector may cause connect failure.
- (3). After complete wiring, please tape all connectors firmly to prevent damaging by water or loosing.
- (4). Power cable need to install behind the ACC (key starter) and fuse to prevent running out the power of battery.
- (5). Main Engine needs to be installed firmly in flat place to prevent damaging by shocking.

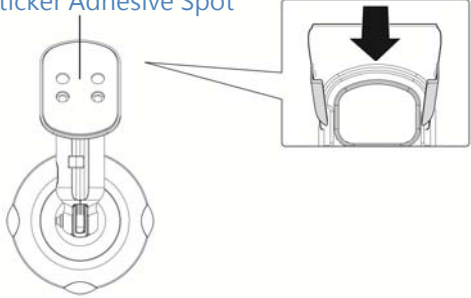
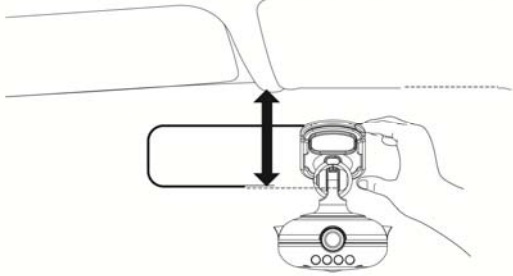
## 2. Camera Installation Diagram

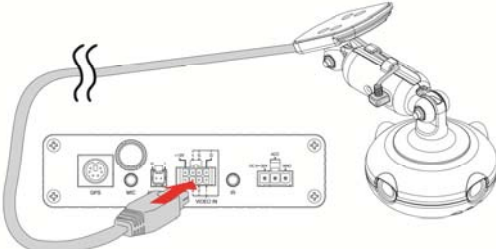
<p>1. Install camera on windshield by adhesive bracket.</p>	<p>2. Pick up a best location for installation.</p>
<p>Sticker Adhesive Spot</p> 	
<p>3. To adjust a best view angle.</p>	<p>4. To connect power cable to Mini USB hole.</p>
	
<p>5. To connect the other end with the "Video In" slot in DVR.</p>	
	



### Notice

- (1). The best installation location of camera in the windshield should be under the area that wiper could achieve.
- (2). Before using, please adjust proper time-setting and time zone setting in OSD directly.

### 3. How to install Memory Card

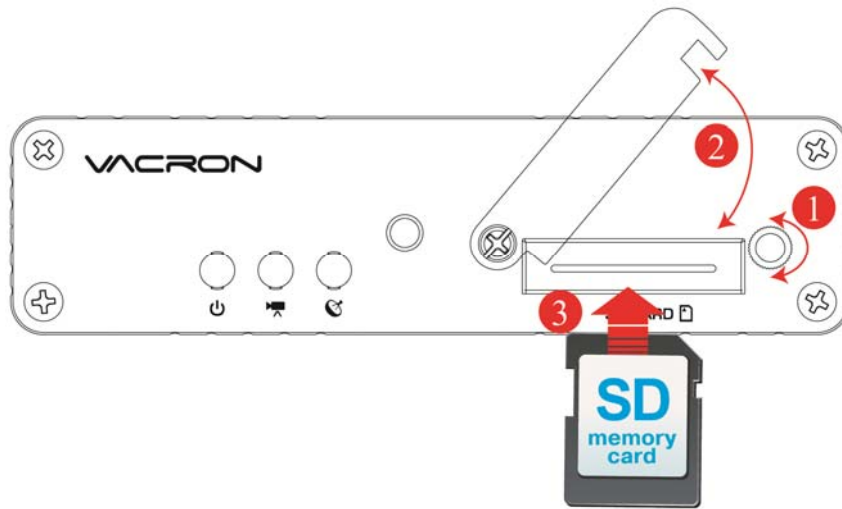

- (1). To loose the screws then move the cover to install memory card.
- (2). See how to format in another chapter.

Note : SD Card is optional accessory



#### Notice

- (1). Suggest to use Transcend SDHC Card (Class 10/ 4G at least)
- (2). When using a new card, please format SD card in main engine or in player first.
- (3). Before using the memory disk, please format the disk first using the software player in the CD-ROM. If not, device will automatically erase all data in the memory disk before recording.
- (4). Please do not use Micro SD card adapt to SD card for using, it may cause connect fail when vehicle moving and shocking.
- (5). Memory card has life limit. Please check it regularly and to playback the footages in your PC will be better for card using.

## F. ON/OFF

- **ON :**

Insert SD card into slot in main engine, connect the power to start. Waiting for around 30 seconds, it will be booted when the power light on.



Screenshot of booting

- **OFF :**

Turn off the power supply, it will stop recording automatically. You can take off the SD card to read footages in PC by card reader.



- **Light Signal :**

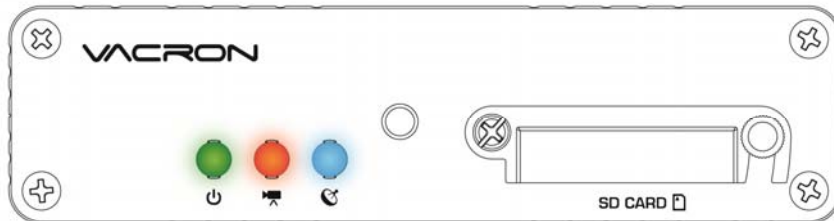







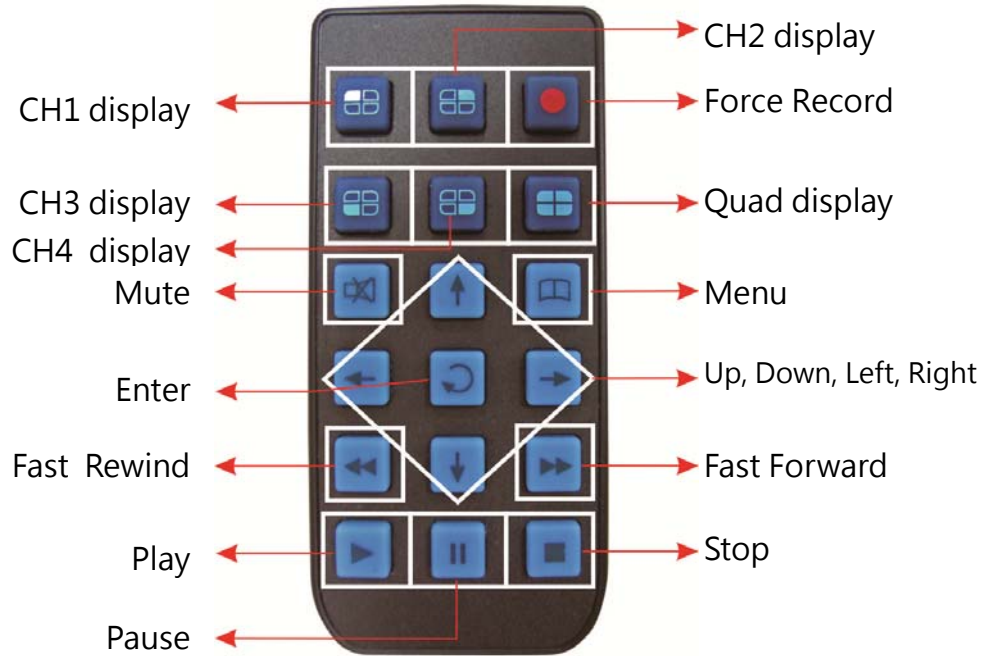





- **Power Light (GREEN) :**  
No light = No power supply.  
Light on = Stable power supply.
- **Recording Light (RED) :**  
No light = No recording.  
Light Blinked = On recording.  
Light Blinked Fast = On force recording.
- **GPS Light (BLUE) :**  
No light = Not position yet.  
Light Blinked = Position successfully.

Notice: When you playback in main engine, it will stop recording at the same time.

## G. Remote Controller Introduction



Button Description		
	CH 1~4	Choose 1-4 CH to display footages when in real time monitoring or playback.
	Force Record	Event Recording will be saved particularly. It will save every 3 minutes before and after the event to make sure it's not be overwritten.
	Quad display	Show quad display when in real time monitor mode.
	Mute	When in real time monitor mode, do not record audio.







	Menu	Open main menu or back to front page.
	Up, Down, Left, Right	When enter menu, use these 4 buttons to choose function.
	Enter	Enter the function you choose or save the setting you choose.
	Fast Rewind	Rewind the footage when playback.
	Fast Forward	Forward the footage when playback.
	Play	To playback footage when in real time monitor mode.
	Pause	To pause the playing when in real time monitor mode.
	Stop	To stop playing and back to front page when playback.

<p>How to check if the remote controller is workable?</p> 	<ul style="list-style-type: none"> <li>√ Check the mercury cell is installed in correct direction. (Check the pole)</li> <li>√ Check if the cell power is exhaust.</li> <li>√ Check if the sensor is covered.</li> <li>√ Check if it nears by Fluorescent Lamp.</li> </ul>
---	--





## H. Real Time Monitoring Mode

The screenshot of real time monitoring mode:



Signal	Description
	On recording.
	GPS sensor position successfully.
	Microphone on.
	Hand Force Recording on.
	G-Sensor is triggered, force recording automatically on.
1/2/3/4	Display of channel 1/2/3/4
	Vehicle speed. It needs to do setting through player in advance. (Please see detail in part of "SD card format." )

### Remote Controller Operation Instruction

- To show single 1~4 channel display · press 
- To show quad display, press 
- To open menu, press 
- To playback, press 

## I. Playback Instruction

There are two ways to playback recorded footages: in main engine and in PC.

### 1. To playback in main engine

- Press play button (▶) under Real Time Monitoring Mode, then select “show all playback list (see picture as below)” and press enter button(↵) to see all list.









- Playback list

Select the footage you want to playback, press enter button(↵) to view video.



▶ : This file is recorded by hand force recording.

 : This file is recorded by automatically force recording.

- Playback operation instruction
  - (1).When playing, if you want to view single channel display, select and press channel button (.
  - (2).When playing, if you want to view quad display, press quad button (.
  - (3). If you want to stop playing, press pause button (.
  - (4).To dissolve pause instruct and continue to play, press play button (.
  - (5).If you want to leave playback mode, press stop button (.

## 2. To Playback in PC

- (1). Connect the SD card with PC by card reader or proper device, execute the player



CarBox2.exe (in CD-ROM)

- (2). Click playback icon () to open the list.



- (3). Select correct memory card drive, then it will show file list, choose and click the file you want to play.

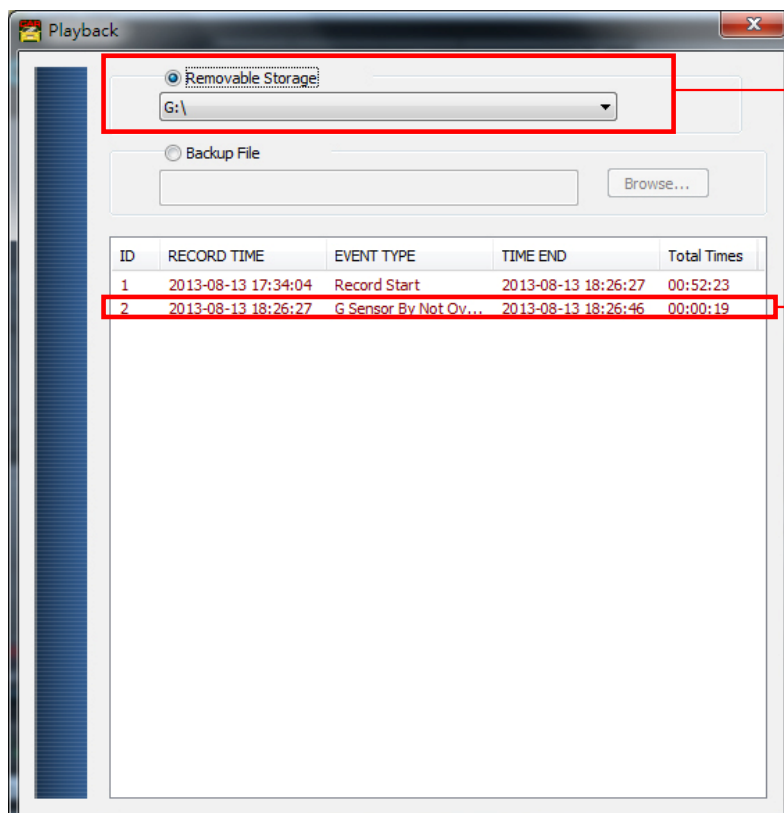

1. Select correct drive (memory card).

2. Select file to play.

(4). The screenshot of playing









## J. Menu Operation On The Mobile DVR

### 1. Main Menu

- Main menu setup :

- (1). Press the remote control  icon to start the main menu in live monitoring mode
- (2). Press  icon to move the light bar, then press the related function · then press  to enter the related setup.
- (3). Press the  icon to return the main menu

- Select menu :



(Main menu 1/4)

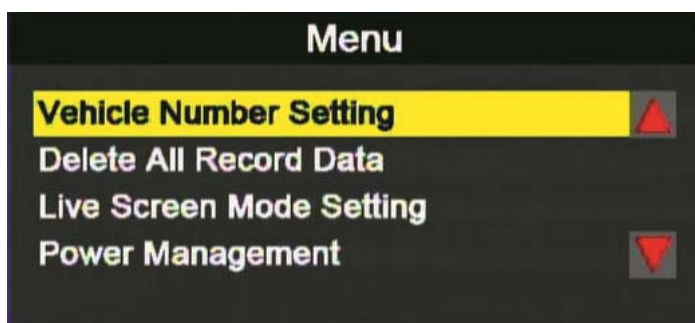

(Main menu 2/4)



(Main menu 3/4)

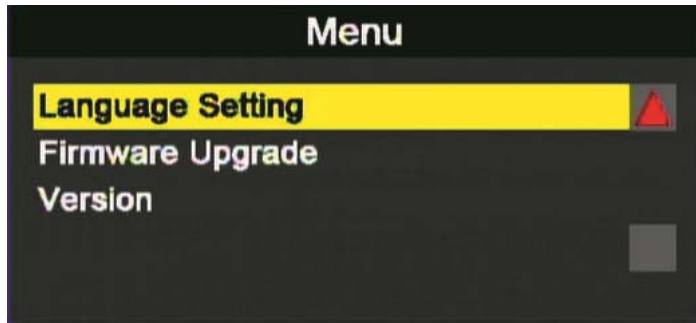

(Main menu 4/4)

## 2. Menu OperatiOn And Parameter Setup

### (1). Video recording setting



Main menu - Record setup



Record setup setting page

fps	NTSC	D1	5-15
		CIF	5-30
	PAL	D1	5-15
		CIF	5-25
Quality	Normal	Better	High

## (2). Parking setting



Main menu - Set Parking

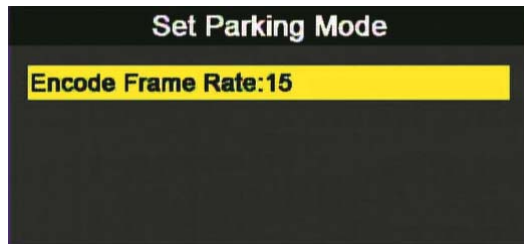

Set Parking Mode setting page

## Mode

- This is for the purpose to setup the fps after vehicle power off.
- Fps setting · less then 『Recording setup』 fps

## (3). Color adjustment

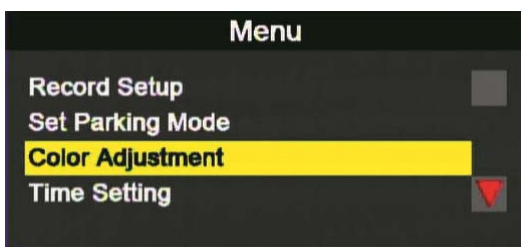





Main menu - Color



Color Adjustment setting page

## Adjustment

- Video setting : use   key to select
- Video brightness /Contrast/Color: Use   to move the light bar , choose target and press  to save the setup °

## (4). Time setting



Main menu - Time setting



Time setting page

- Please input the time:  
2013/08/14 18:54:20 GMT 08:00 :  
「yyyy/mm/dd/hh/mm/ss/time zone」
- DVR will adjust the time and time zone automatically from the GPS.

## (5). Vehicle number setting

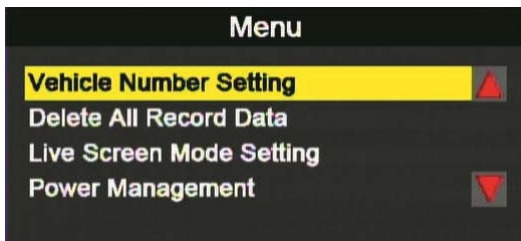
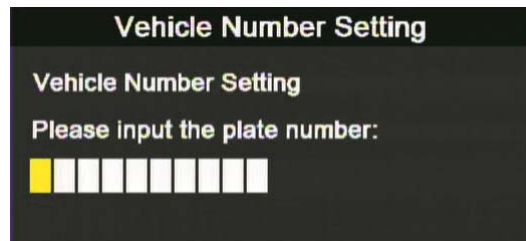
Main menu - Vehicle Number  
Setting

Vehicle Number Setting page

- Input range : A~Z, 0~9.

## (6). Format the disk

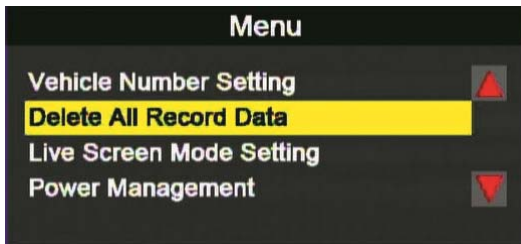
Main menu - Delete All  
Record Data

Delete All Record Data page

★ Note: All footage in SD card will be erased after format.

## (7). Live screen mode setting

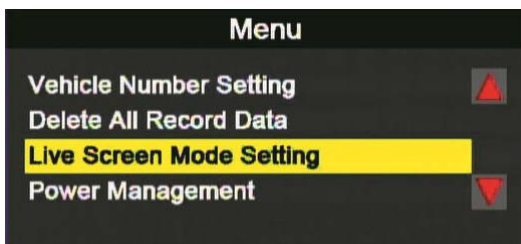
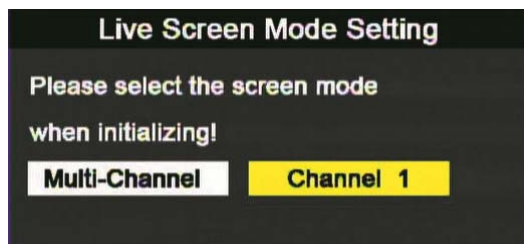
Main menu - Live Screen  
Mode Setting

Live Screen Mode Setting Page

- Multi Channel : Show 4 CH video on display.
- Channel 1 : Show CH1 video on display.

## (8). Power Management

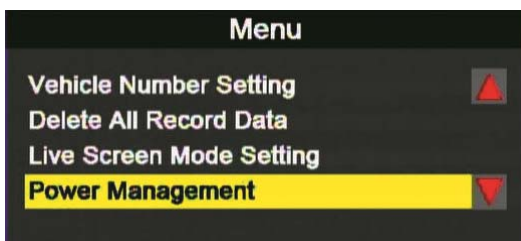
Main menu - Power  
Management

Power Management page

- Setup how many times you want to record after vehicle power off.
- Recording period setting : From 00:00 、 00:30 、 01:00...Etc. It divided into 30 min as a part, the longest can set as 23:30. If you want to keep always recording, please choose "Never shut down" .

### (9). Alarm setting

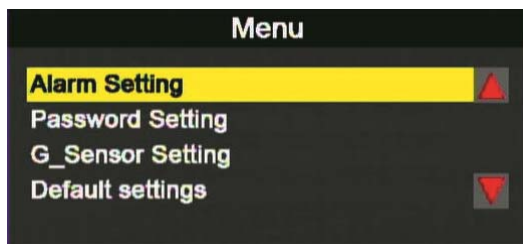

#### Main menu – Alarm Setting

#### Alarm Setting page

- Alarm options : OFF 、 CH1 、 CH2 、 CH3 、 CH4 。
- After finish the setting, when the CH1~CH4 be triggered, The Setting CH will show on the display with full screen.

### (10). Password setting

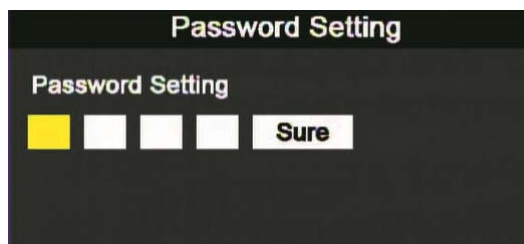
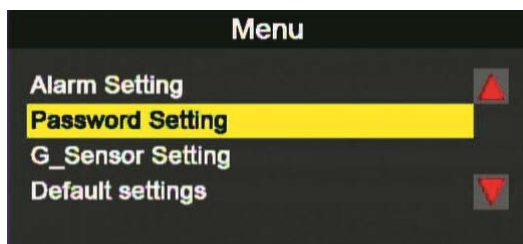

#### Main menu - Password

#### Password Setting page

#### Setting

- If you have setup the password, system will ask you enter the password when you want to enter the setup menu, or when you playback the footage. During entering procedure, all character just show 『 \* 』
- Character accepted : A~Z & 0~9

★ Please remember your password.

## (11). G-Sensor setting

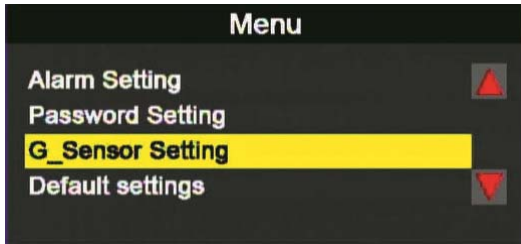

Main menu - G\_Sensor

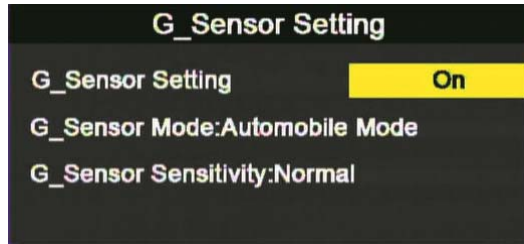

G\_Sensor Setting page

## Setting

- G\_Sensor options : On 、 OFF.
- G\_Sensor Mode : Sedan mode 、 Truck mode.
- G\_Sensor sensitivity options : Min 、 Low 、 medium 、 High 、 Max.

★After setup the sensitivity, when car impact from outside, DVR will start into 『Force Recording』 mode to prevent event recording do not be overwritten.

## (12). Restore to Factory setting



Main menu - Default Setting

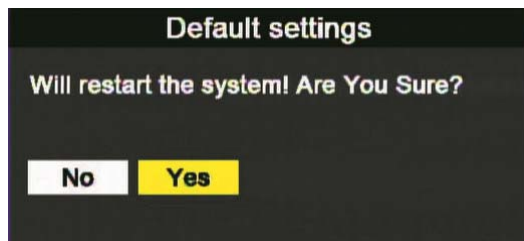

Default Setting page

★ After Restore to default setting, DVR will reboot automatically and restore all default setting.

## (13). Language setting

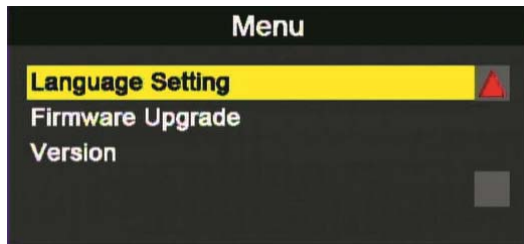
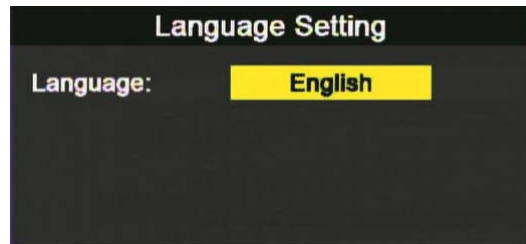
Main menu - Language  
Setting

Language Setting page

- Language : English / Traditional Chinese / Japanese / Korean / Russian / Spanish / German

## (14). Firmware upgrade

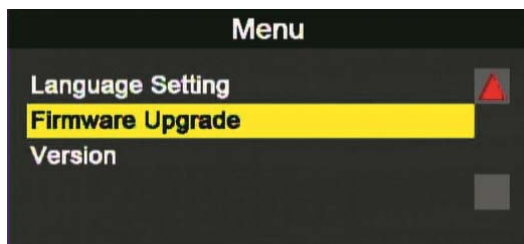
Main menu - Firmware  
upgrade

Firmware upgrade page

- Before execute, please save the firmware files to the SD card, and insert the SD card into DVR
- DVR can not interrupt power source when updating the firmware. After firmware update, the DVR system will reboot automatically.



## (15). Firmware version

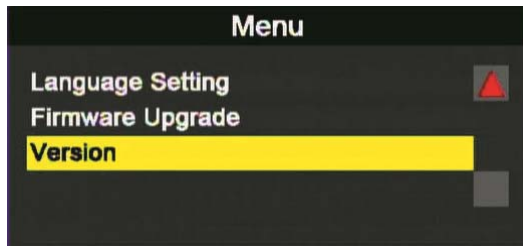

Main Menu - Version



Version page

- You can check the firmware version here to make sure if you need to update the firmware

## K. Player (On the personal computer)

Execute the program CarBox2.exe  · the player will open as follows:

★Note : Your PC need install DirectX 9.0 or above.

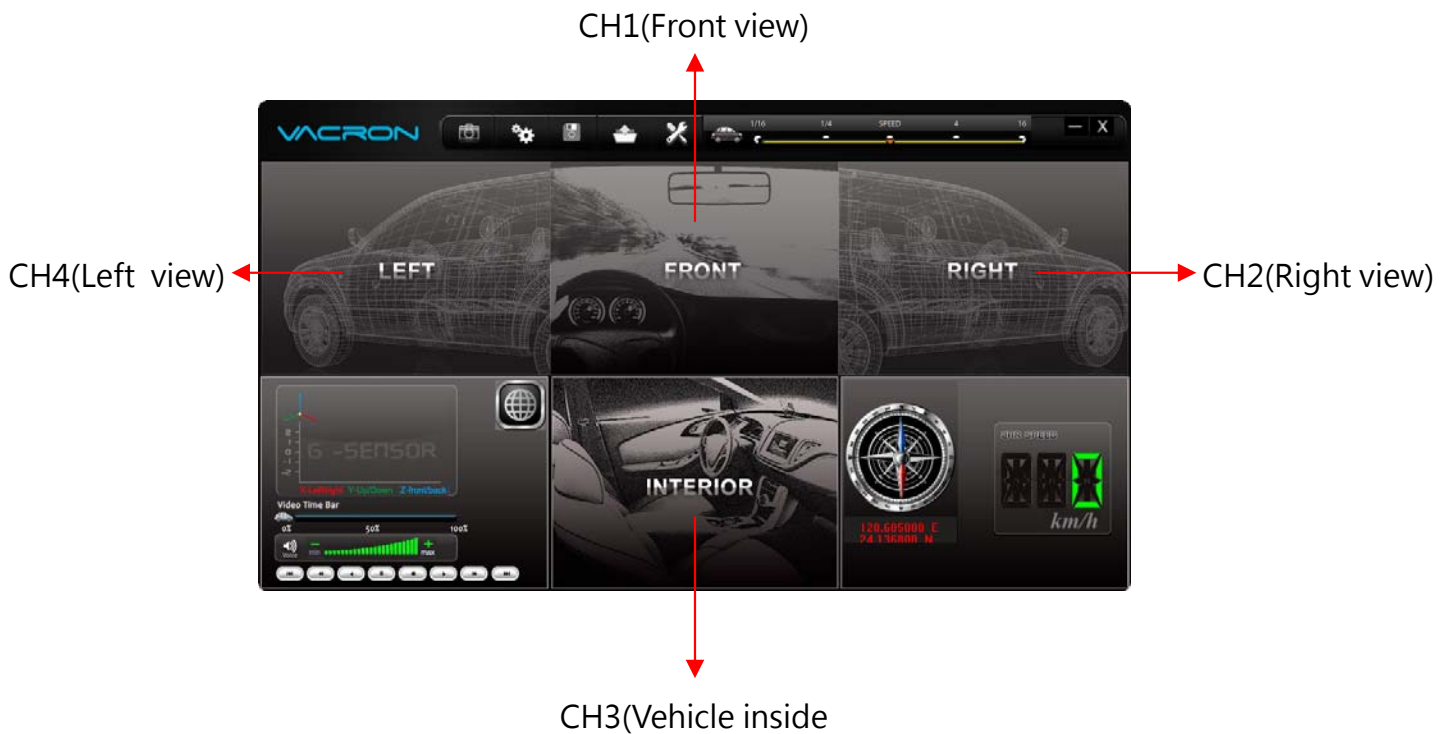

### (1). Capture

 Capture : Screen shoot

- Click the  icon to capture the footage screen. The Image will be save as .bmpfile format.
- Player will show the backup folder automatically. The default directory is the Snapshot folder. (Under the Player installation folder)

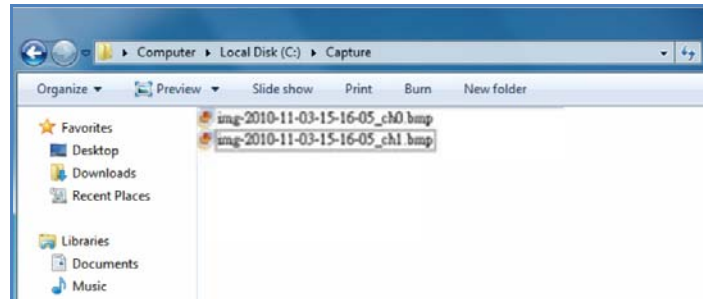

## (2). Configuration



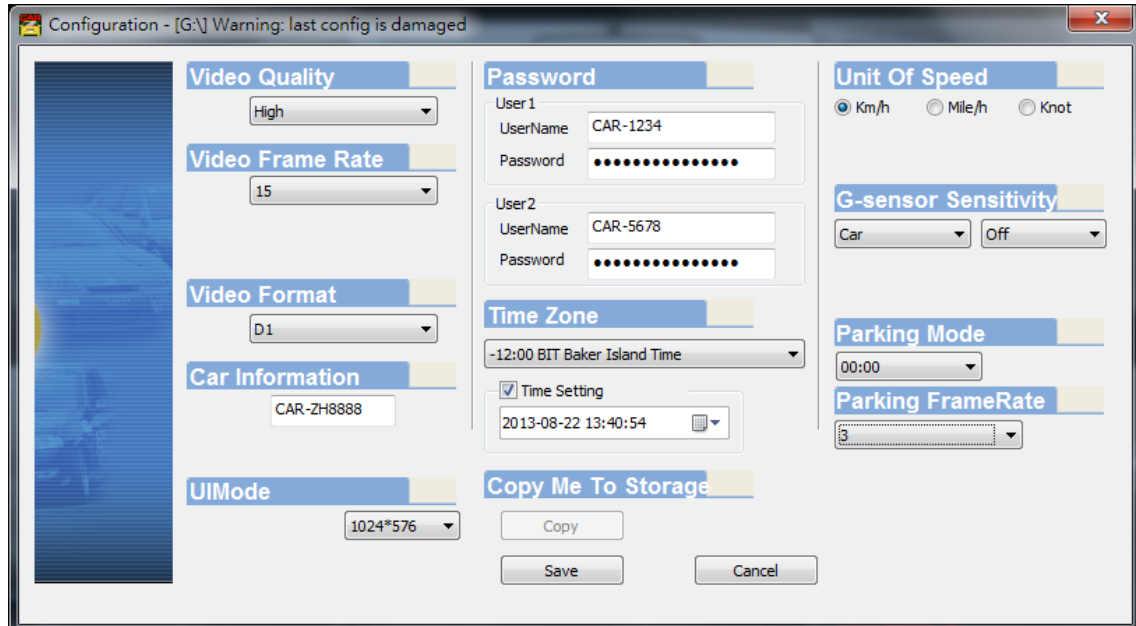

Configuration: Setup the general setting.

Before execute this function, please insert the SD card into your computer. When finish all setting and click 『 Save 』 , all the setting will save to the SD card. When you insert the SD card into your DVR, the DVR will read the setting and follow the setting to start recording.

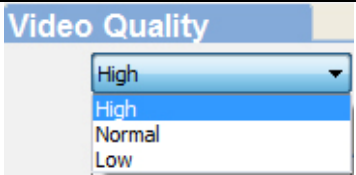
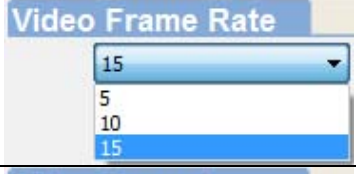
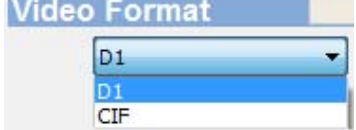
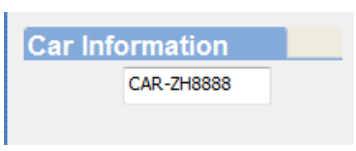
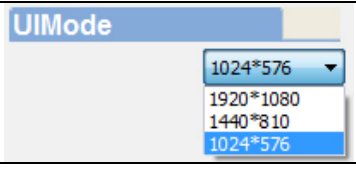
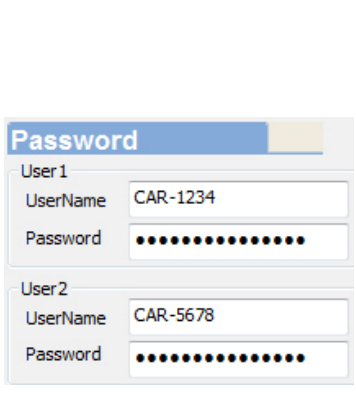
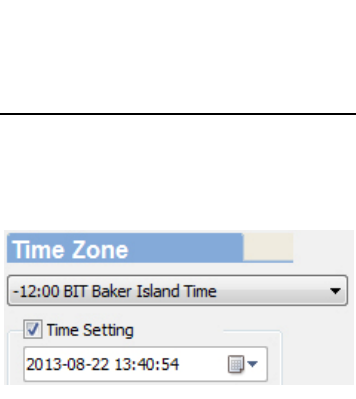

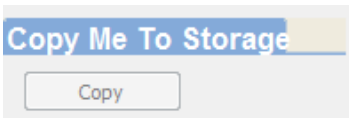
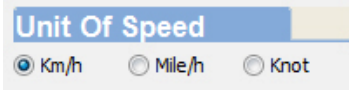
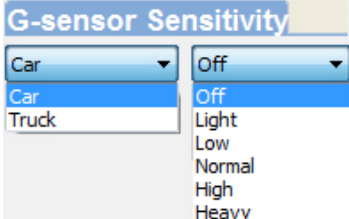
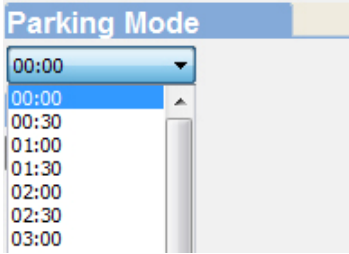
1	Image Quality		Choose the resolution: High / Normal / Low
2	fps		Set the fps D1 resolution : 5~15 CIF resolution : 5~30
3	Image Format		Two format: D1 / CIF
4	Car Information		Car License, Driver (For Company car, Taxi, or fleet)
5	UI Mode		Player Screen size: 1920*1080 / 1440*810 / 1024*576
6	Password		Encrypt the SD card to prevent others who not permitted to access the SD card. Streng length: 15 character. After setting the password, all actions, like Playback footage, setting, format SD, need the password. ★ Note : Upper character and lower is different.
7	Time Zone		GMT setting, to adjust the time zone. ( need GPS signal to adjust the accurate time zone automatically) If choose 「 Time setting 」 , you need to set the time by yourself.

8	Copy Player to SD Card		Copy all Player' related files to SD card.
9	Speed Unit		Set the speed unit Km/hr Mile/hr Knot
10	G-sensor Sensitivity		G-sensor mode: Sedan/ Truck/ Sensitivity setting : (Min/Low/Normal/High/Max)
11	Power management		You can choose how long the DVR will auto power off to stop recording after vehicle power off. Setting range from 00:00~23:30 and "Never Power Off"
12	Fps after vehicle power off		fps setting to recording fps after vehicle power off

### (3). Backup



Backup folder : Choose the folder that backup file will save.

You can backup the footage on the SD card to your computer for data backup. Choose  icon to start the backup function as the following :

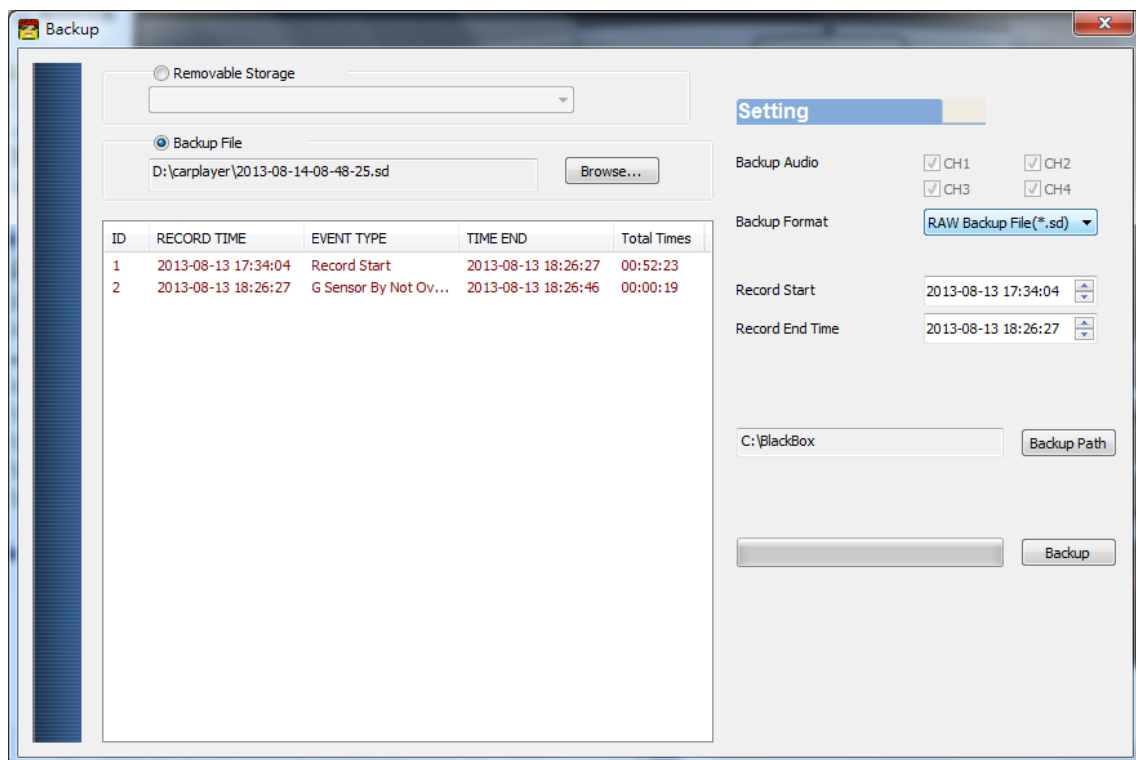

Step1. Choose the SD card Disk Drive or Backup File.

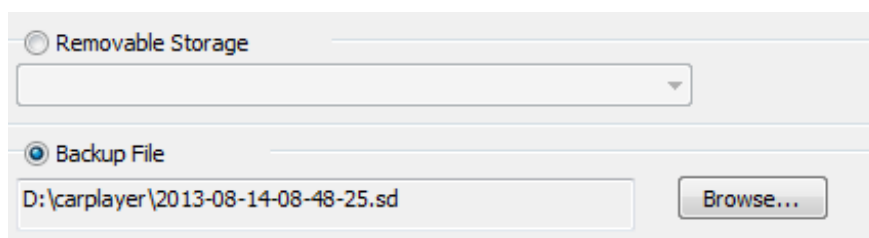

Step2.Choose the file you want to backup on the SD card.

ID	RECORD TIME	EVENT TYPE	TIME END	Total Times
1	2013-08-13 17:34:04	Record Start	2013-08-13 18:26:27	00:52:23
2	2013-08-13 18:26:27	G Sensor By Not Ov...	2013-08-13 18:26:46	00:00:19

Step3.Choose backup file audio and format

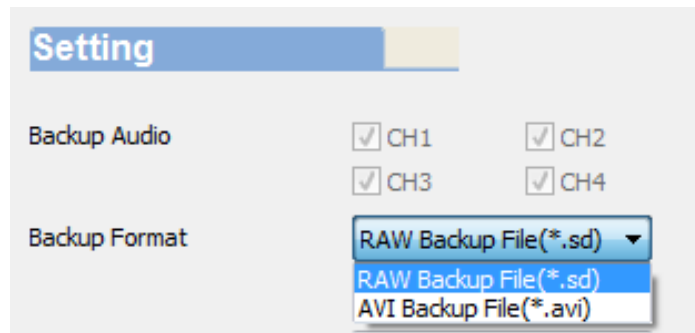

Backup format :

● SD format

	2013-06-06-09-49-33.sd SD File 104 MB	*.sd
---	---	------

● AVI format

	2013-06-06-09-50-56-C 00:00:30 55.2 MB	.avi
---	--	------

Note : \*.sd format file contain image/ speed/ location and G-SENSOR data. \*.avi format only can backup the video and audio. We recommend you backup as \*.sd format.

Step4. You also can choose a period to backup the footage during the period.

Record Start	2013-08-13 17:34:04
Record End Time	2013-08-13 17:50:27

Step5. Choose the backup folder.

C:\BlackBox	Backup Path
-------------	-------------

Step6. Start to backup.

	Backup
--	--------

Step7. Backup Completed.

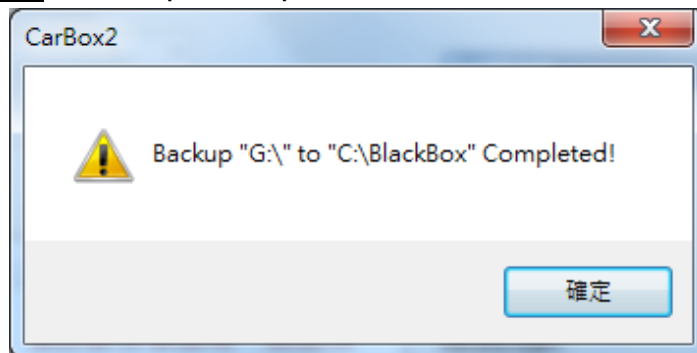



#### (4). Playback



Playback the footage : Choose the file in SD Card or in the computer to playback.

The screenshot shows a 'Playback' window with two radio buttons: 'Removable Storage' (unselected) and 'Backup File' (selected). Below 'Backup File', there is a text field containing 'D:\carplayer\2013-08-14-08-48-25.sd' and a 'Browse...' button. A table below shows a list of records with columns: ID, RECORD TIME, EVENT TYPE, TIME END, and Total Times. Two rows are highlighted with red boxes: row 1 and row 2. Red arrows point from the text '1. Choose the SD or Backup File' to the 'Removable Storage' area and from '2. Choose the file' to the second row of the table.

ID	RECORD TIME	EVENT TYPE	TIME END	Total Times
1	2013-08-13 17:34:04	Record Start	2013-08-13 18:26:27	00:52:23
2	2013-08-13 18:26:27	G Sensor By Not Ov...	2013-08-13 18:26:46	00:00:19

#### (5). Format



Format : Format the SD Card · Restore the SD card format to windows format. Language setting, Firmware version. For Format and restore SD card, please reference the next item

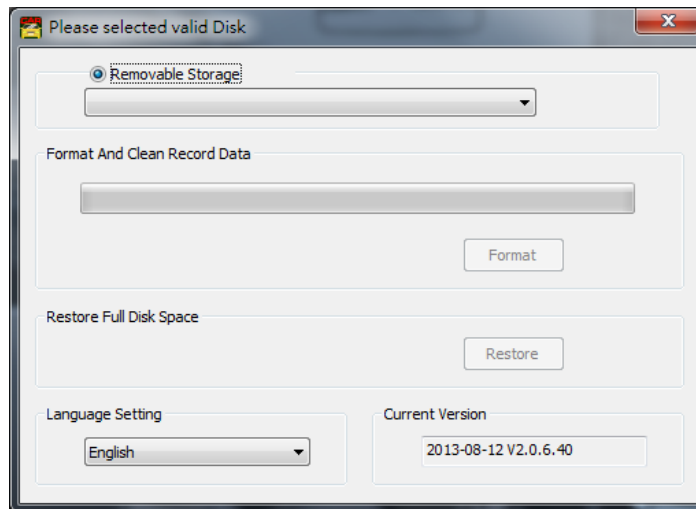

(6). Footage playback speed

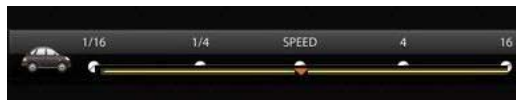

Footage playback : Can adjust form 2x~16x, and 1/2x~1/16x

(7). MAP



Map : Show the location on the Google Map, can show the location and drive path. (GPS is optional)

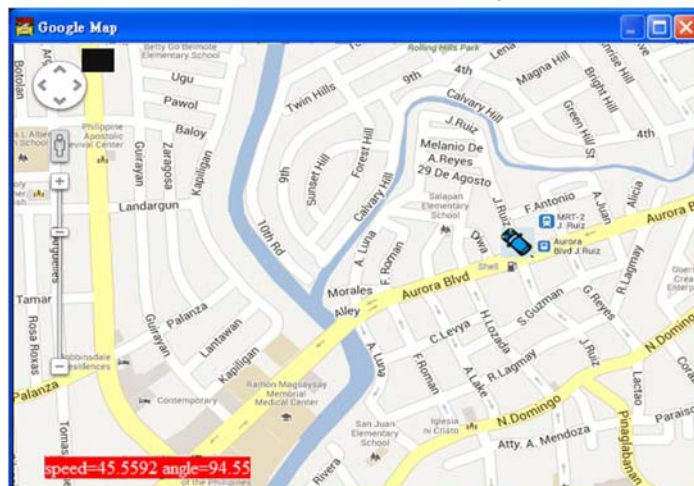

(8). G-sensor

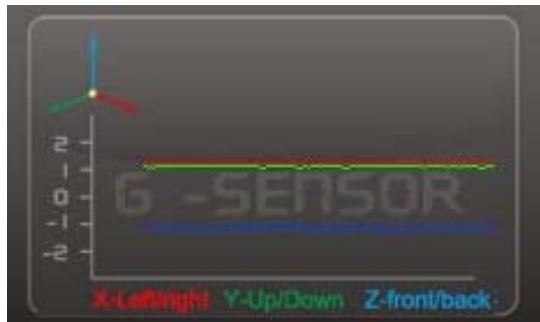

G-SENSOR : When G-Sensor be triggered, system will record the X 、 Y 、 Z axis data.

X : horizon change.

Y : Front and rear change.

Z : Vertical change.

(9). Footage playback speed



Playback speed is adjustable from 2x~16x and 1/2X~1/16x.









## (10). Volume



Volume control bar : Click the + or - to adjust the volume.

## (11). Control panel



1		Previous File
2		Previous Frame
3		Backward Play
4		Pause
5		Stop
6		Play
7		Next Frame
8		Next file

## (12). Direction and Latitude

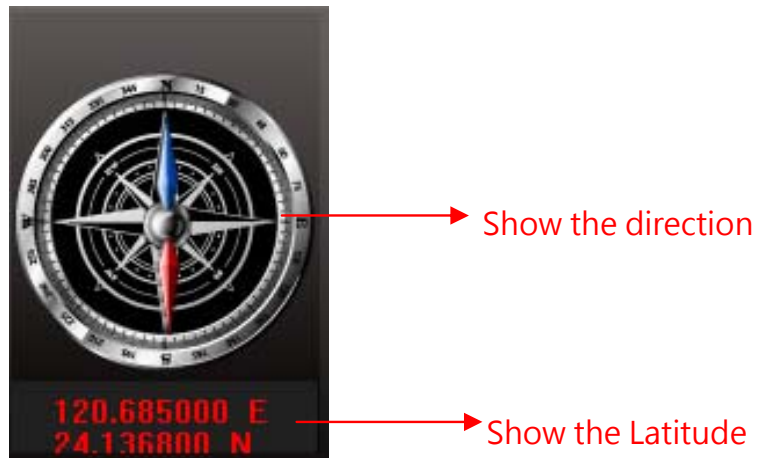

Show the direction and Latitude and position.

## (13). Speed



Speedometer : Set the speed unit.

## L. Format the SD card

Before format the SD card, please backup all files in your card, this procedure will erase all files on the SD card.

Q. When you need to format the SD card?

A. Our vehicle use different format for the SD card, so when you buy a new card , you need to format the new SD card

There are two ways to format the SD card - 「 On the Recorder 」 and 「 On the computer 」 .

### 1. Format on the recorder

Step1.Use the remote control. Press the 「 Menu 」 button to enter the select menu , choose the 「 Format SD Card 」 item.



Step2.Move the light bar to choose the 「 Format SD Card 」 item, then press 「 Yes 」 to proceed the SD card format procedure.

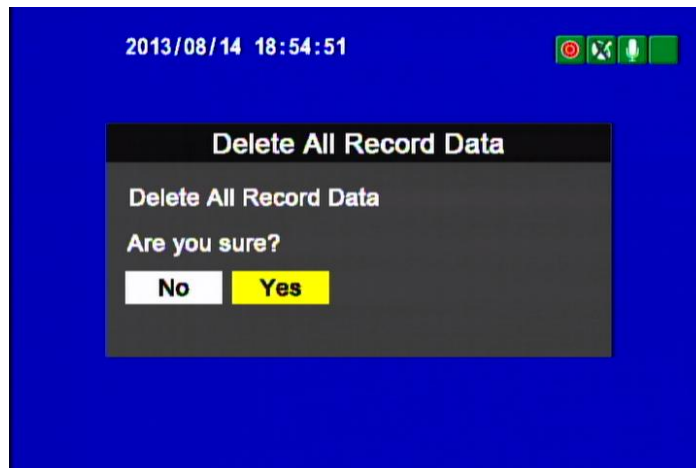

Step3.When your LCD menu back to the screen as follows, the format procedure is finish.



## 2. Format in your computer

Step1.Pulg your SD card into card reader or SD slot in your computer. Execute the  CarBox2.exe software (bundle in our product CD)

Step2.Click the  format tool icon, then you can into the format function screen ◦

Choose the SD card, press the 「Format」 icon

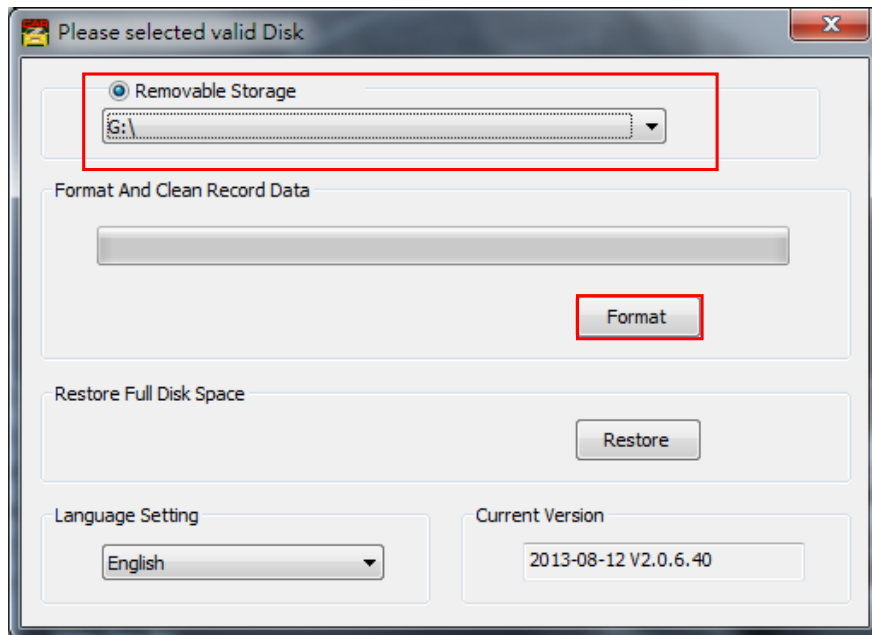

Step4. Windows pop up the menu as follows and ask you to answer 『 Start to Format this device? 』 , Please make sure the disk drive is right, then press 『 Yes 』 .

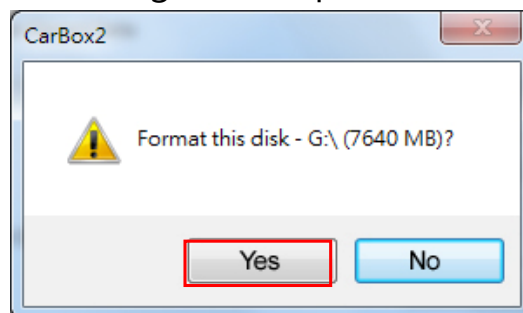

Step 5. When the format procedure finish, the following pop window will show on your screen.

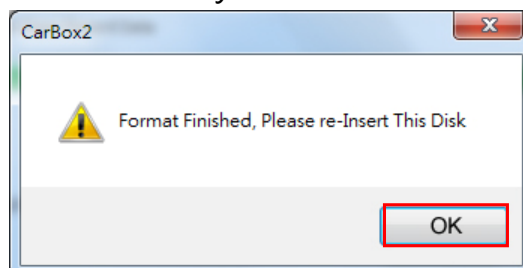

(After finish the SD card format, please remove your



SD card from the computer and insert into the slot again. Then you can start to proceed the related setup on the Player can do. Then insert the SD to your recorder, your recorder is ready for recording the footage. )

## M. Restore the SD card

Before restore the SD card, remember to backup your footage on the SD card, if needed.

Q. When you need to restore the SD card?

A. When you want to use the SD card on other purpose, you need to proceed the "Restore" function. This procedure will format the SD card to the normal windows format. Only proceed this procedure, you can use the SD card as a normal storage device.

Step1. Remove the SD card from your recorder, insert into your card reader, then plug into your computer USB slot, execute the bundle Player  CarBox2.exe (In our CD)

Step2. Click the  Format icon · choose the SD card, then press 『Restore』

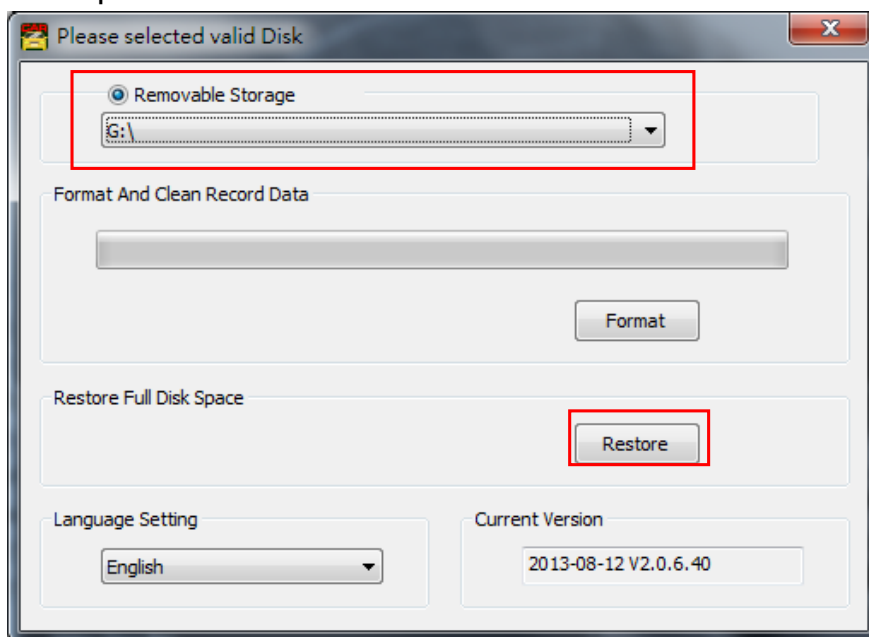

Step3.The following window will pop up, Click 『Yes』 to start restore the SD.

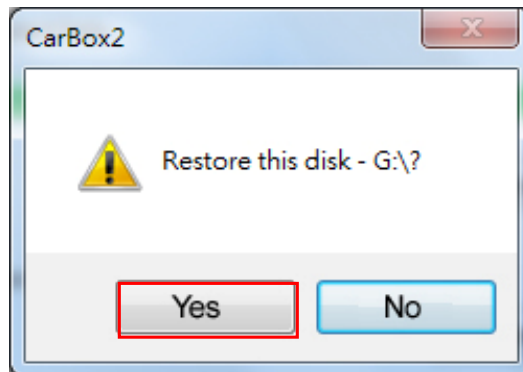

Step4.Now system will pop up the window to proceed the format procedure, please choose 『Quick format』, then click 『Start』.

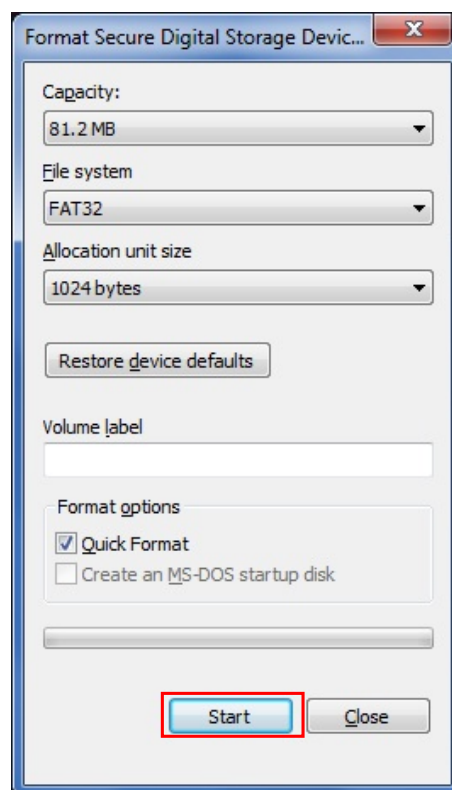

Step5. Click 「Yes」 to start formatting the SD card

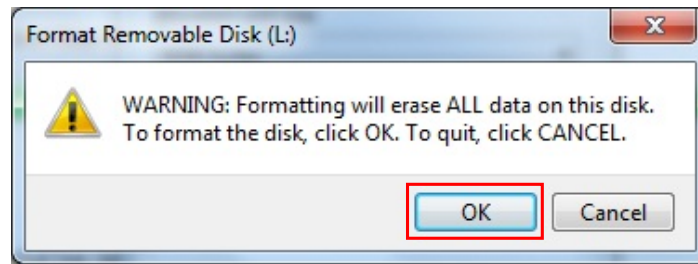

Step6. Click "OK" to finish restore SD card.



Step7.After finished, press 『OK』。Then the SD card format is normal windows format.

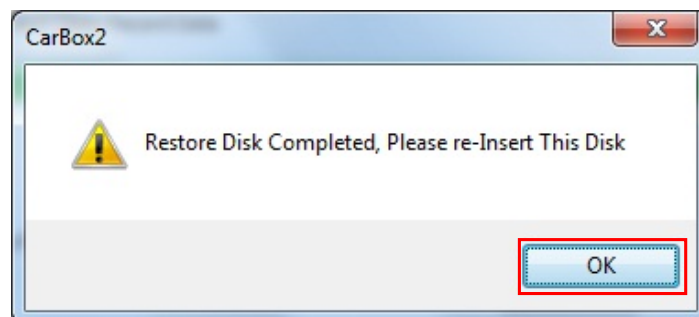



More product information  
Please visit VACRON web-site  
<http://www.vacron.com>

Made in Taiwan