

2-Channel Mobile Video Recorder User Manual



2013 MAR. V1.1



Disclaimer

This document is deemed accurate at time of writing. Due to continuous hardware and software improvement, images and software screenshots depicted here may be different from the actual products.



Improper installation or use may cause hazard such as electrical shock and fire. The user and installer are advised to read this manual carefully.

The manufacturer provides no warranty against any damage, loss, or claim arising from negligence, improper installation or use, or transportation accidents.

The performance of GPS may be affected by external factors out of control of the device. Such factors may include weather, satellite signal strength, installation location of the GPS antenna, and other unforeseeable factors.

The manufacturer provides no warranty for LCD pixel defect.

Caution

This manual provides general guidance to installing the device on vehicles. However, as the actual electrical wiring may vary from vehicle to vehicle, the user and installer are advised to follow safety advices from the vehicle manufacturers.

Please seek help from professional technician in installing the product.

Table of Contents

A. Key Features	3
B. Specifications	4
C. Product Description	5
D. Memory Disk.....	6
E. Cables	7
F. Vehicle Installation.....	8
G. Remote Controller	9
H. Recording	10
I. GPS.....	11
J. Live Display	12
K. Player Software on PC	14
L. File Backup.....	16
M. Configuring the Memory Disk	18
N. Video Playback.....	21
O. Image Snapshot	23
P. Formatting the Memory Disk	23
Q. Player Language Setting	25

A. Key Features

- Suitable for motorcycle and small vehicle.
- Durable, water resistant all-aluminum casting.
- Up to 2 channel video cameras input. Simultaneous recording of video and audio (with external microphone)
- Built-in 3 inch TFT LCD screen for convenient camera viewing angle adjustment and video footage playback.
- Advanced MPEG4/AVC (H.264) compression for ultra small file size.
- Adjustable G-sensor sensitivity according to road condition and vehicle type. On detection of strong shock, the device automatically starts emergency recording.
- In emergency recording, the device saves data including 1~3 minutes before and after the event for complete record. The footage is not subject to rewrite from continuous recording.
- Low power consumption and excellent heat radiation. Lithium battery is not used to eliminate risks of overheating and "explosion".
- Automatically starts recording at ignition.
- If GPS receiver is installed, the recorded route will display on video playback on computer with support of GOOGLE map.

B. Specifications

Items	Description
Video input	2 Channel
Frame Size	NTSC: 30 fps (D1); PAL: 25 fps (D1)
Power Supply	DC12V, 250mA
Operating Temperature	-15°C~ 50°C
Storage	SD card, 4G or above, class 10 or better. (SanDisk and Transcend recommended)
Recording	Automatically starts continuous recording when powered on
Recording Content	Date, time, video, audio, G-sensor data and GPS data (only when GPS receiver is installed).
Playback	Software player (on computer) and remote controller (directly from unit)
Audio input	External microphone (optional)
Time setup	Automatic calibration by GPS signals. If GPS signal is unavailable, internal clock will be used.
G-Sensor	Internal 3-axis accelerometer

Accessories

- (1) Standard: (a) 2.5 M Power Cable (b) SD Card Reader
(c) Remote Controller (d) Driver CD
(e) Quick Guide (f) Velcro Tape
- (2) Optional: (a) SD card, 4GB or above, class 10 or above
(b) External GPS Receiver
(c) Microphone (no waterproof, need to be installed in a appropriate position)
(d) Bracket (two type)



bracket (FE30E0900000)



bracket (FE30E0900001)

C. Product Description

Panel

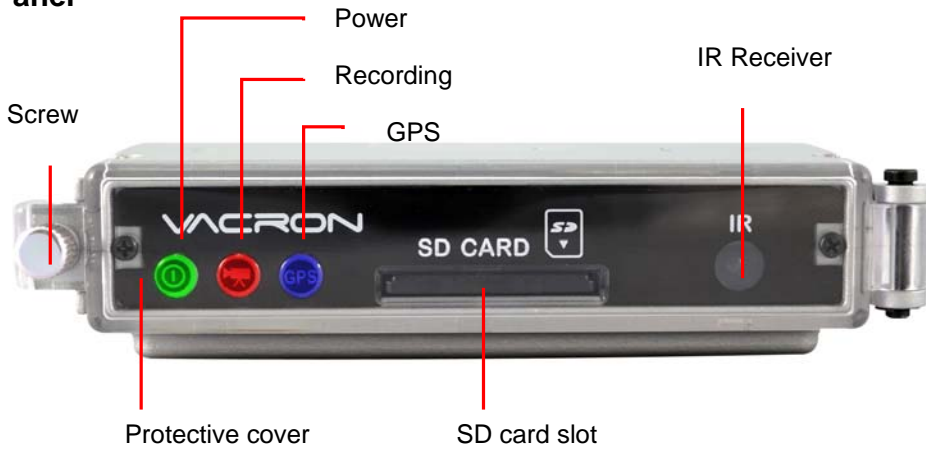

Dimension (mm)

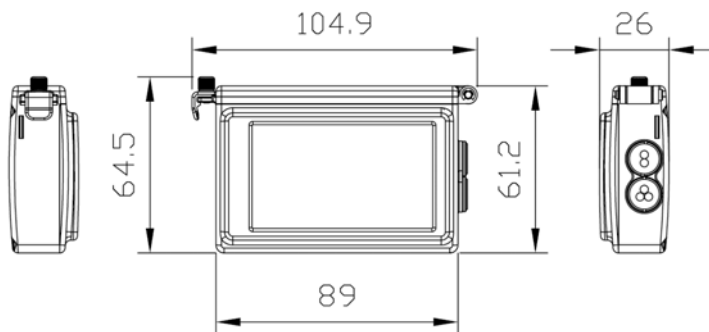

D. Memory Disk

Plug the memory disk to recorder:

- (1) Loosen the screw in counterclockwise rotation, and open the protective cover to insert/remove SD card.
- (2) Tightly close the cover afterward.



NOTE: The memory disk needs to be purchased separately

Accessing the memory disk from computer

- (1) Insert the memory disk to the USB reader.
- (2) Plug the reader to the USB port of your computer.
- (3) Launch the player software from the included CD

See also:

- Player Software on PC (p14)
- File Backup (p16)
- Configuring the Memory (p18)
- Playback on Computer (p22)



Note

- (1) SD card from SanDisk or Transcend is recommended. (class 10, 4GB above)
- (2) Before using the memory disk, please format the disk first using the software player in the CD-ROM. If not, device will automatically erase all data in the memory disk before recording.
- (3) To ensure recording quality, please do not use adapter card with Micro SD card. Doing so may lead to bad connection due to shock and vibration.
- (4) All memory disks have limited lifespan. Please regularly watch videos on PC and check the memory disk to ensure proper functioning.

E. Cables

Cables

- (1) Power connector, male
- (2) Channel 1 Video Input*
- (3) Channel 2 Video Input*
- (4) External microphone input
- (5) External GPS antenna input



NOTE: Use this device with compatible vehicle cameras

Power Cable

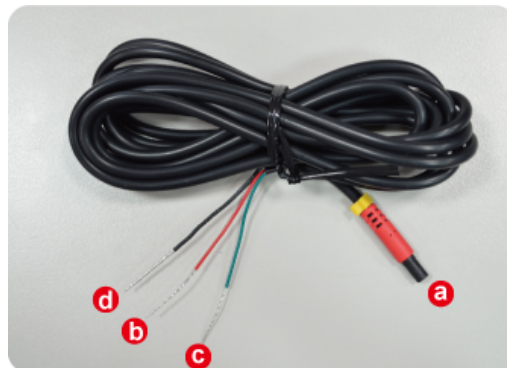

- (1). Power Adapter - Female connector.
- (2). Live Wire: Wire to ACC power or the positive pole of Engine Starter. (+)
- (3). Earth Wire: Wire to Negative Pole. (-)
- (4). Null Line: Wire to earth wire. Covered with heat-shrinkable tube to avoid short with motorcycle body.

F. Vehicle Installation



Warning





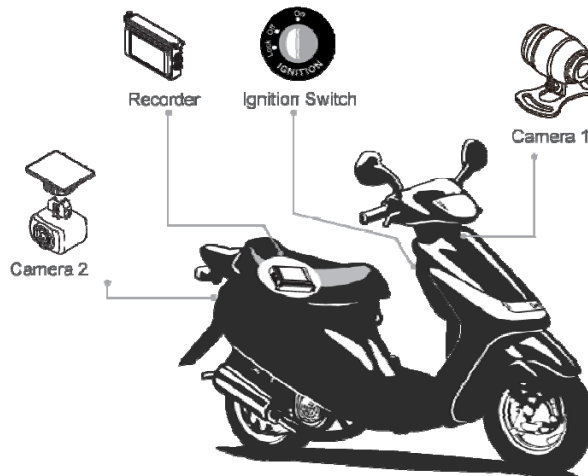

- (1) Please install this device with the help of professional technician to avoid damaging your vehicle.
- (2) For installation by none-technician, please use tapes instead of boring tools to avoid damaging the electrical and gasoline system.
- (3) For safety, switch off ignition before installation, and please keep away from gasoline pipeline and tank.
- (4) Before inserting wires through holes, temporarily wrap the terminal with tape to prevent bad connection from accumulated dirt or debris.
- (5) Tightly seal all electrical connection with tape to prevent loose connection or leak leaking to the connection.
- (6) Connect the power behind the key ignition and fuse (not directly to the vehicle battery) to avoid depleting the battery.
- (7) The device should be fixed to the vehicle. Tumbling inside the storage trunk will damage the device.

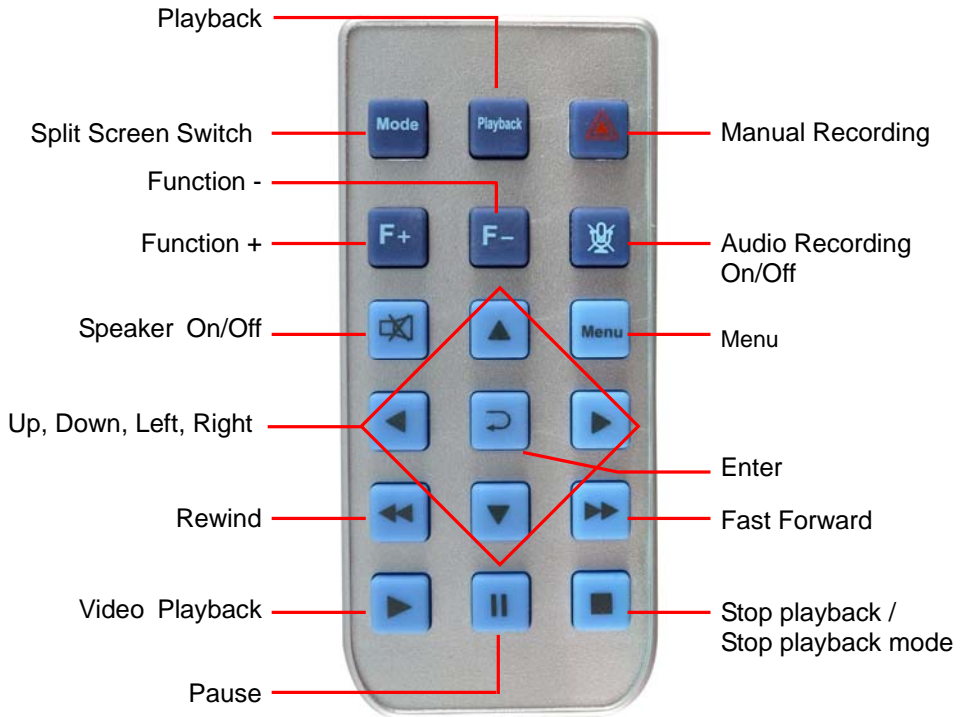
Example Installation



G. Remote Controller



Icon	Function	Description
	Split Screen Switch	Full screen / split screen switch
	Playback Mode	Open the playback list and switch to playback mode
	Manual Recording	Saves video from 1~3 minutes before and after press of the button as emergency recording.
	Function +	Lighten the screen
	Function -	Darken the screen
	Microphone On/Off	Turn on or off audio recording

H. Recording

There are two modes of recording:

- Continuous** After the device is powered up, it automatically starts recording continuously until it is powered off.
- Emergency** In the event of emergency, the device saves data from 1~3 minutes before and after the event. The footage is not subject to rewrite from continuous recording. Emergency recording may be activated manually or by G-sensor.

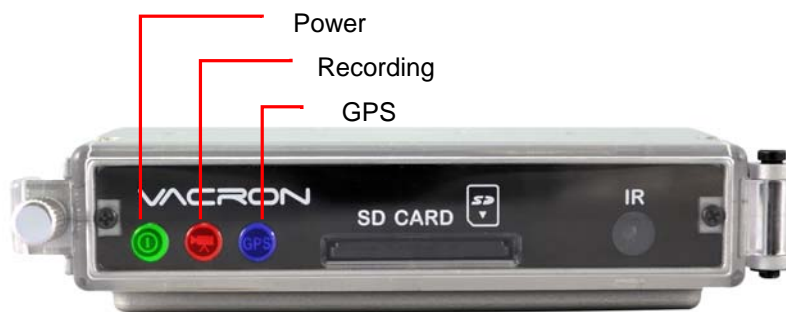

In continuous recording, the recording indicator (red) will flash at normal speed. In emergency recording, the recording indicator will flash at fast speed.

Continuous Recording

When the device is powered on, the LCD screen will show a splash screen and then the firmware version.

The device needs around one minute to boot. During boot-up, the power indicator (green) will flash. Then the recording indicator (red) will flash to indicate that recording is in progress



Splash Screen

Manual Recording

To start manual recording, press the  button on the remote controller. The recording indicator (red) will flash at quicken speed to indicate that emergency recording is in progress.

G-Sensor Recording

When the internal G-sensor detects abnormal shock, the device automatically switches to emergency recording. To set G-sensor sensitivity, please refer to “Configuring the Memory ” (page 18)

I. GPS







Flashing GPS indicator (blue) means the system is either searching for GPS signal or calculating location. Continuous GPS indicator light means GPS positioning is ready.

NOTE:

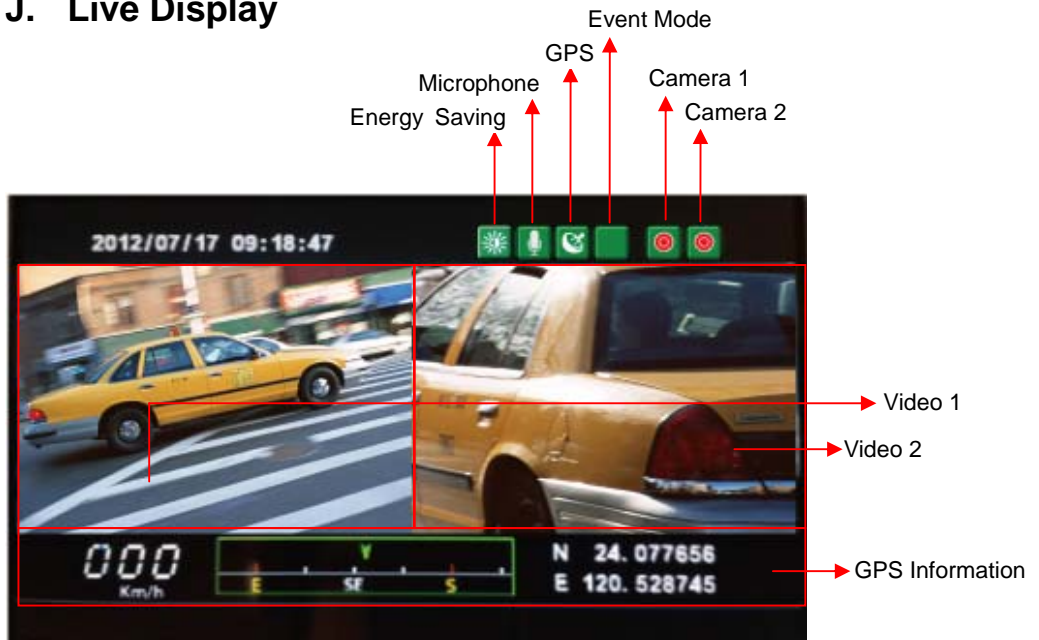

The time for the device to determine coordinate may be influenced by external factors such as location of the GPS receiver, weather, and satellite signal strength.

J. Live Display



- (1) If the screen shows   on top right, it means that both channel 1 (left) and channel 2 (right) have video signal. A  icon indicates that one channel has no video input.

Note: Even if there is no video input, the device still record that channel (as long as there is power and SD card has no error). The channel screen will display a blue background

- (2) Event Mode: a  icon indicates normal (continuous) recording. A  icon manual recording. A  icon indicates emergency recording activated by the G-sensor. See "Recording" (page 10)

- (3) Press  on the remote controller to switch between CH1 full screen, CH2 full screen and 2-split screen display (see below)



CH1 full screen











CH2 full screen



2-split screen Image

- (4) Press  on the remote controller in LIVE mode to show firmware version

Firmware Version: 2001

- (5) Press  on the remote controller to turn off audio recording ( will show on the screen). A  icon indicates that audio recording is on.
- (6) A  icon means either that the device is calculating coordinate or that there is no satellite signal. A  icon means that GPS is ready.
- (7) You can use the player software to configure the display brightness on the SD card.  indicates daylight mode, and  indicates night mode.
- (8) LCD brightness: Press  or  on the remote controller to adjust the screen brightness. The screen will show something like below:



K. Player Software on PC

Run the player software  (included in the CD).

NOTE: The software requires Direct X version 9.0 or above.

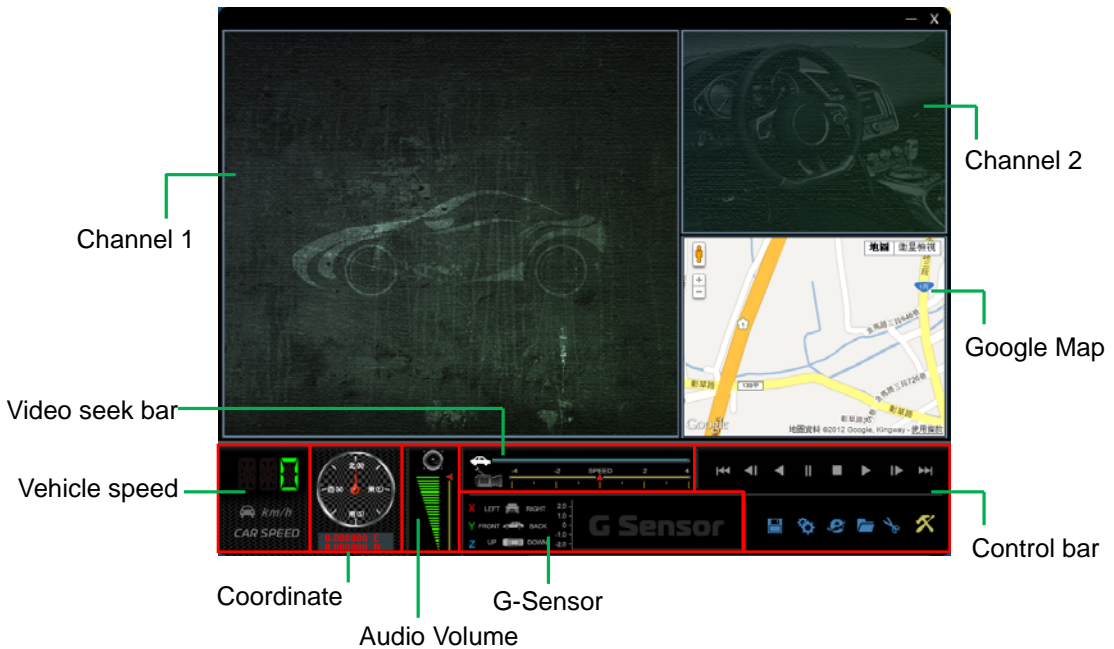

NOTE: GPS coordinates, speed and map data are only available if GPS receiver is connected to the device.

Play the video / file



Seek Bar

Play Speed

Seek Bar

Drag the car icon to quick search video.

Play Speed

Change playback speed (2x or 4x faster, normal, or -2x or -4x slower)

G-sensor

Display vehicle vibration as recorded by internal accelerometer.

- X Left and right movement
- Y Front and rear movement
- Z Vertical movement

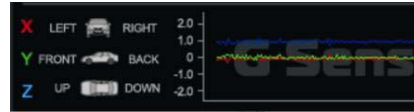

Control bar



	Previous File		Stop
	Previous Frame		Play
	Play Backward		Next Frame
	Pause		Next File



	Video backup.
	Configuration
	View map in a separate window
	Open video (from file or memory disk)
	Snapshot
	Memory disk format and language setting

Google Map

If GPS data is available (a GPS antenna is attached to the device at the time of recording), the screen will show the vehicle route using Google Map

To open the Google Map in a separate window, select

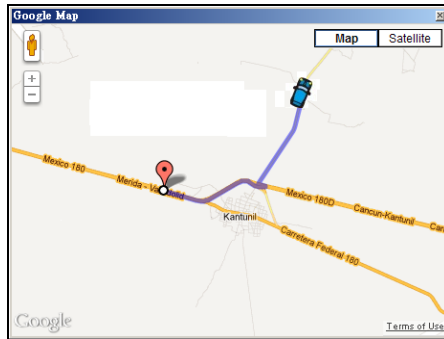

L. File Backup

On the player software, select  and the following window will open.

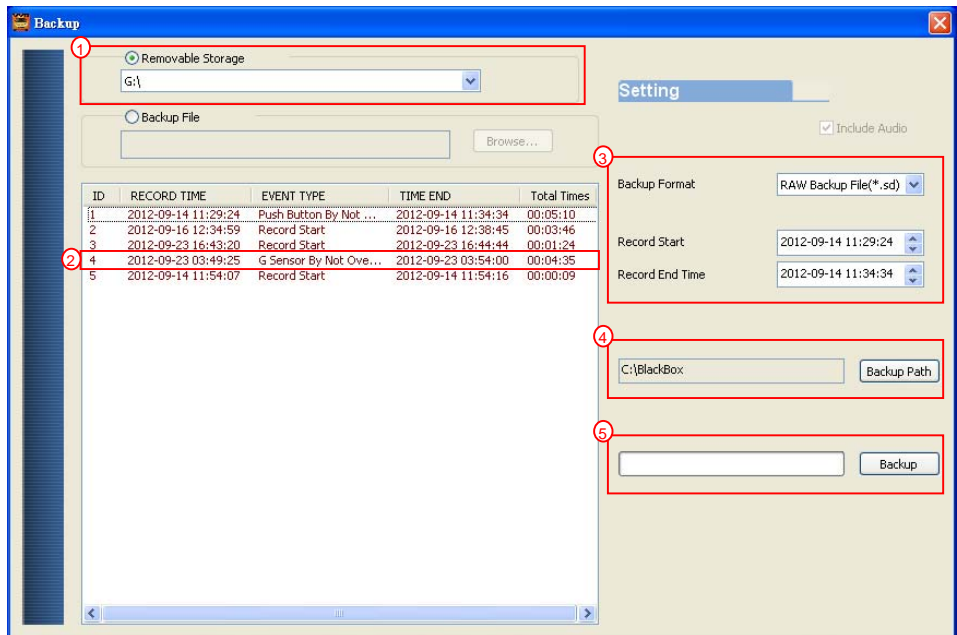

To backup video:

(1) Select the path of the memory disk

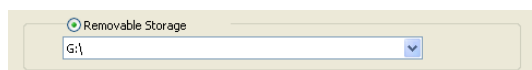

(2) Select the footage that you want to backup

ID	RECORD TIME	EVENT TYPE	TIME END	Total Times
1	2012-09-14 11:29:24	Push Button By Not ...	2012-09-14 11:34:34	00:05:10
2	2012-09-16 12:34:59	Record Start	2012-09-16 12:38:45	00:03:46
3	2012-09-23 16:43:20	Record Start	2012-09-23 16:44:44	00:01:24
4	2012-09-23 03:49:25	G Sensor By Not Ove...	2012-09-23 03:54:00	00:04:35
5	2012-09-14 11:54:07	Record Start	2012-09-14 11:54:16	00:00:09

(3) Select the Backup Format:

Backup Format	<input type="text" value="RAW Backup File(*.sd)"/> <input type="text" value="RAW Backup File(*.sd)"/> <input type="text" value="AVI Backup File(*.avi)"/>
Record Start	<input type="text" value="2012-09-23 03:49:25"/>
Record End Time	<input type="text" value="2012-09-23 03:54:00"/>



(a) Raw file (.sd)

Backup all footage information (video, audio, and GPS data).
This player software is needed to open the file



(b) AVI File (*.avi)

Backup video and audio to a format that other media player can open. GPS data will be lost.

	2011-11-19-12-26-52-CHN01.avi 視訊短片 24,794 KB	chn01 indicates channel 1 footage
	2011-11-19-12-26-52-CHN02.avi 視訊短片 6,998 KB	chn02 indicates channel 2 footage

(4) Step 4: Select the destination folder of the file.

<input type="text" value="C:\BlackBox"/>	<input type="button" value="Backup Path"/>
--	--



(5) Step 5: Select Backup to start.

<input type="checkbox"/>	<input type="button" value="Backup"/>
--------------------------	---------------------------------------





M. Configuring the Memory Disk

Before using the memory disk, you need to firstly format and configure the disk. For disk formatting, please refer to “Formatting the Memory ” on page 23.

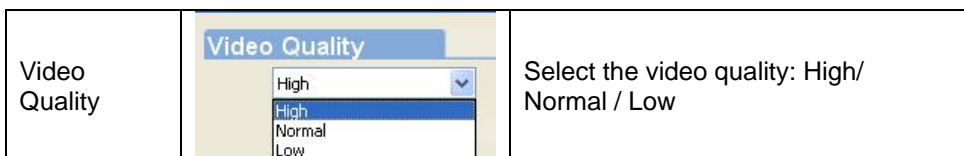
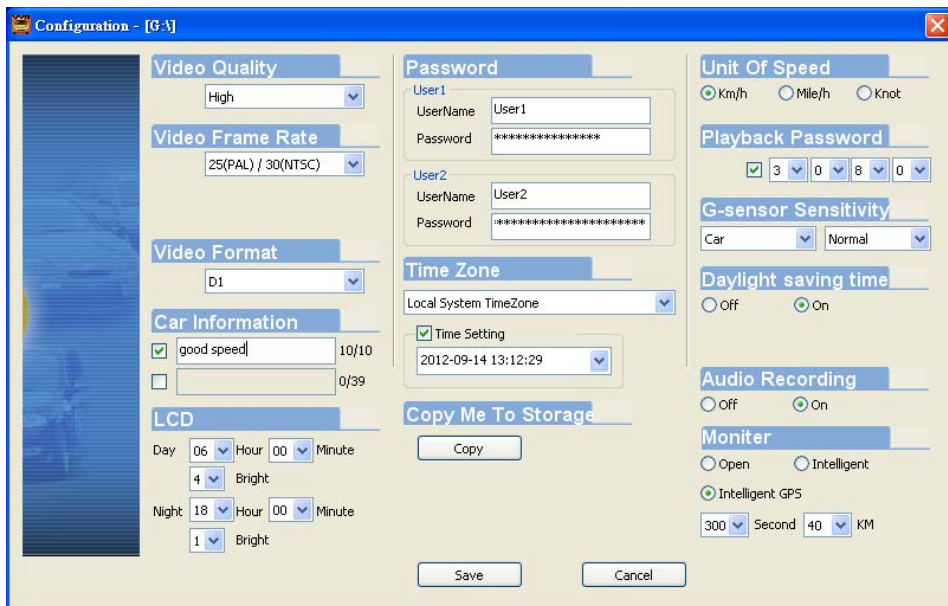
To configure the memory disk:

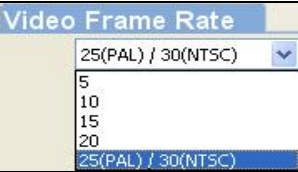
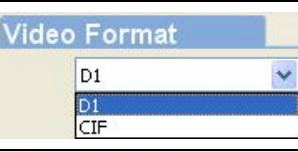
- (1) Plug the memory disk to your computer (see page 6).
- (2) Run the player software  (included in the CD).
- (3) Select  to open the configuration window

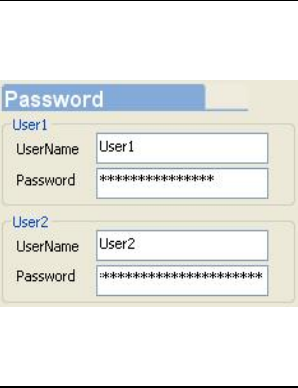

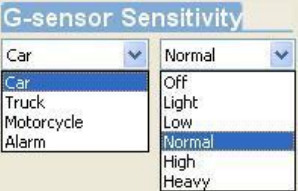

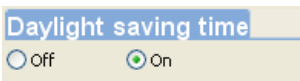
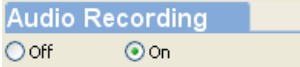
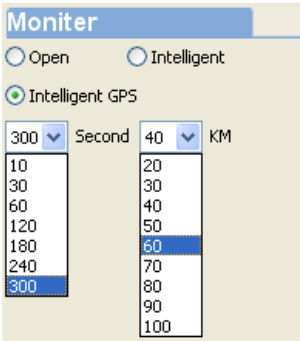
<p>Video Frame Rate</p>		<p>Set the number of frames per second. NTSC: 5, 10, 15, 20, 30 PAL: 5, 10, 15, 20, 25</p>
<p>Video Format</p>		<p>Set the frame size D1 720 x 480 (NTSC) 720 x 288 (PAL) CIF 360 x 240 (NTSC) 360 x 288 (PAL)</p>
<p>Car Information</p>		<p>Enter information such as the driver's name or license plate number to help identifying memory disks when the device is used in a fleet.</p>
<p>Password</p>		<p>This function can encrypt the data and prevent unauthorized access. Maximum letters. Password can contain maximum 15 letters.</p> <p>NOTE: Password is case-sensitive. Always keep passwords in secure location.</p> <p>After passwords are setup, you will need to enter the password to access the disk (video playback, configuration, formatting, etc.)</p>
<p>Time zone</p>		<p>Set the time zone.</p>
<p>Unit of Speed</p>		<p>Set the unit of speed. Km/h: kilometer per hour Mile/h: mile per hour Knot : knot per hour</p>
<p>G-Sensor Sensitivity</p>		<p>Set the G-sensor threshold to activate emergency recording.</p> <p>Five options are available: OFF, very low, low, normal, high, very high</p>

<p>Daylight Saving Time</p>		<p>Turn on/off daylight saving. If this option is enabled, the device's LCD screen will show "DST" after the time stamp.</p>
<p>Audio Recording</p>		<p>Turn on/off audio recording.</p>
<p>Screen Energy Saving</p>		<p>Set when to turn off the screen to save energy:</p> <p>Always On Never turn the screen off</p> <p>Intelligent Turns the screen of after a certain time period of inactivity.</p> <p>Intelligent GPS Turn the screen off when the vehicle reaches certain speed for a certain time period</p> <p>NOTE: Pressing any button on the remote controller will turn on the LCD screen. The screen will turn off again after a period of inactivity.</p> <p>NOTE: Intelligent GPS is only active is a GPS antenna is attached to the device.</p>









N. Video Playback

You may play recorded video 1) on the built-in screen or 2) on computer

On-Screen Playback

Press either  or  button on the remote controller, and the system will switch to playback mode (see below). The device stops recording in the playback mode.



- (1) Press the  or  button to select the footage in the list
- (2) Press the  or  button to select the previous or next page of footage.S
- (3) After the desired footage is selected, press  to play the video.
- (4) To pause video, press . To resume playing, press .
- (5) To stop playing and return to the playback list, press .
- (6) To stop playback and return to live recording mode, press  again

Playback on Computer

On the software player, select  and the following window will appear:

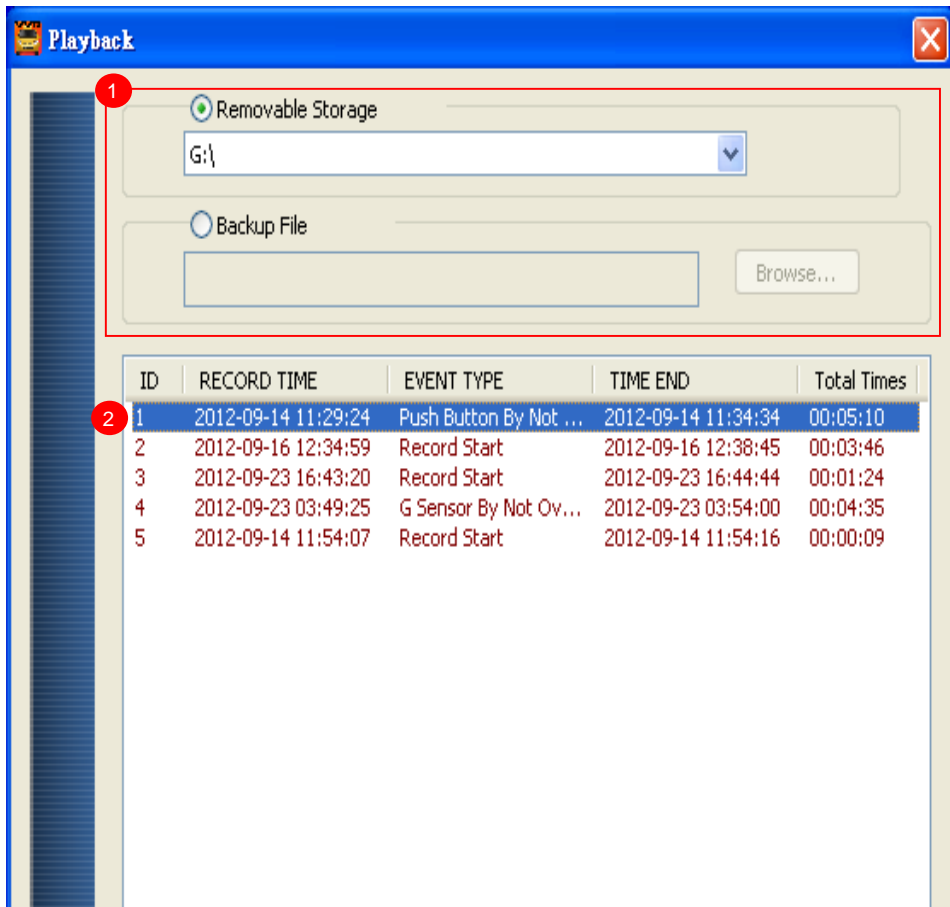

(1) Select the path of the memory disk or a backup file on the hard disk.

(2) Double click the desired footage to play the file.

O. Image Snapshot

While playing a footage on the software player, you may take a snapshot of the current frame by selecting . The player will save the file to *.bmp format and open the destination folder:



P. Formatting the Memory Disk



Important

Formatting/restoring the memory disk will erase all data in the disk.

Formatting the disk

Before using a newly purchased memory disk, or when repurposing an used disk for the device, the memory disk must be formatted first.



Restoring Disk Capacity

If you want to repurpose the memory disk for other uses (e.g. for computer or digital camera), you need to restore the disk. All recorded data will be erased from the disk.

Formatting/Restoring

To format/restore the memory disk:

- (1) Plug the memory disk to your computer (see page 6).

- (2) Run the player software  (included in the CD).
- (3) Select  to open the disk format window.
- (4) Select the memory disk
- (5) Select the Format or Restore button.

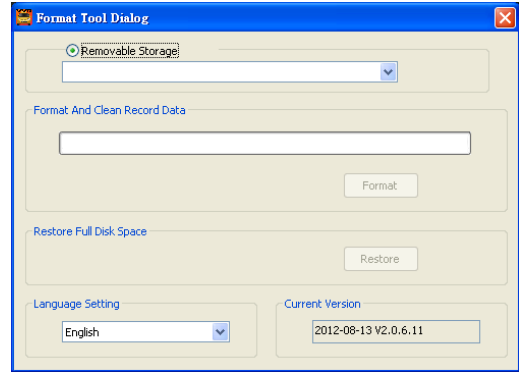

Troubleshooting

- (1) Before formatting or restoring, make sure the disk is not locked.



- (2) If you are still unable to format/restore the memory disk, close the software player, and then re-open the player as administrator:

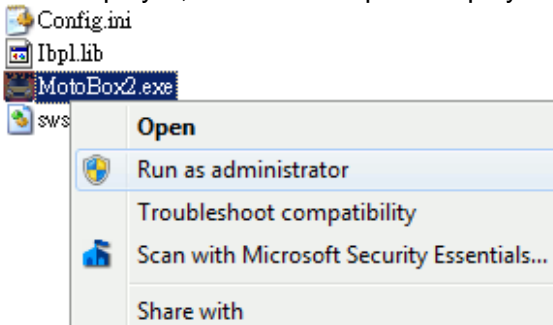



- (3) If you still cannot format/restore the memory disk, log out of Windows and re-log in as administrator.

Q. Player Language Setting

The software player supports multiple language interface (11 languages at time of writing).

To change the user interface language of the software player:

- (1) Run the player software  (included in the CD).
- (2) Select  to open the tool window.
- (3) Select the language setting and then close the window.

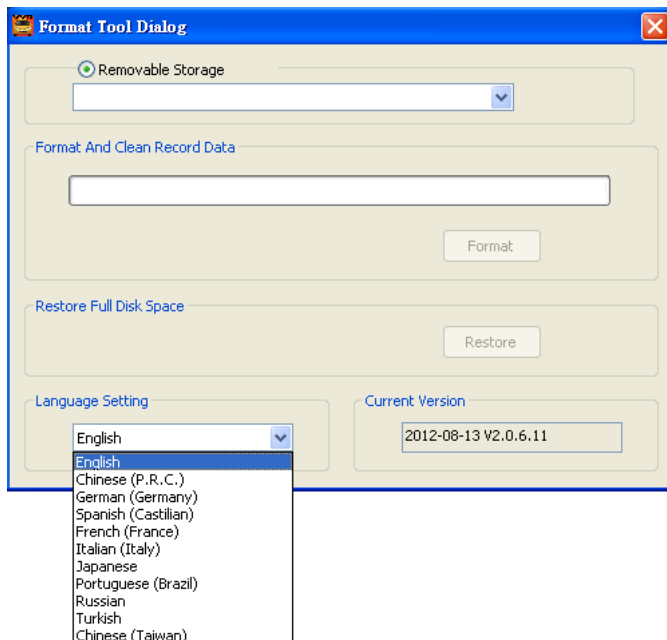

- (4) You need to close and re-open the player for the effect to